

Old Time

and

Bluegrass

WKRULELE

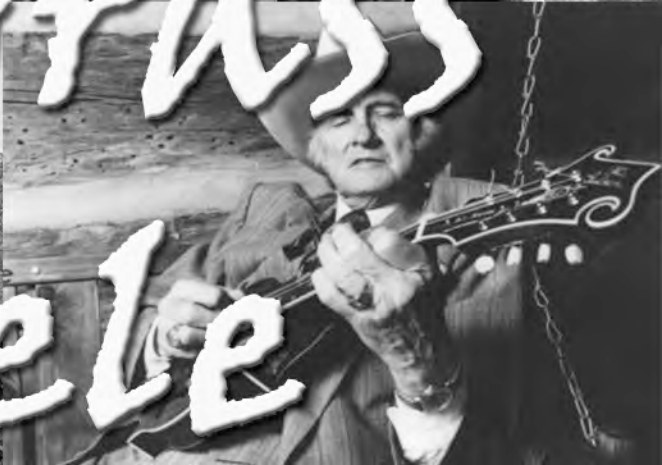

Compiled and arranged by Spencer Gay

The Copyrighted songs provided free herein are for education and thus fall under FAIR USE

This book is not for sale

ukeeducation.org

SONGS

- 1 Alabama Jubilee
- 2 Almost Persuaded
- 3 Always Late
- 4 Amazing Grace
- 5 Angel Band
- 6 Annabelle
- 7 Blue Eyes Cryin' in the Rain
- 8 Blue Moon of Kentucky
- 9 Bye Bye Love
- 10 California Blues
- 11 Careless Love
- 12 Cold Rain and Snow
- 13 Colorado Girl
- 14 Copper Kettle
- 15 Country Roads
- 16 Crazy
- 17 Cripple Creek
- 18 Dark as a Dungeon
- 19 Dark Hollow
- 20 Darlin' Corey
- 21 Dim Lights, Thick Smoke
- 22 Don't Let Your Deal Go Down
- 23 Down to the River to Pray
- 24 Elvis Presley Blues
- 25 Faded Love
- 26 Feast Here Tonight
- 27 Folsom Prison Blues
- 28 Footprints in the Snow
- 29 Fox on the Run
- 30 Funny How Time Slips Away
- 31 Glory, Glory
- 32 Going Down this Road Feeling Bad
- 33 Gold Watch and Chain
- 34 Green, Green Grass of Home
- 35 Happy Trails
- 36 Hard Times
- 37 Help me Make it Through the Night
- 38 Hey Good Lookin'
- 39 Hickory Wind
- 40 Honey You Don't Know My Mind
- 41 I Always Get Lucky with You
- 42 I am a Pilgrim
- 43 I am Weary Let Me Rest
- 44 I Know You Rider
- 45 I Shall Be Released
- 46 I'll Be Your Baby Tonight
- 47 I'll Fly Away
- 48 I'm Movin' On
- 49 I'm Not Afraid to Die
- 50 I'm Thinking Tonight of my Blue
- 51 If I Lose I Don't Care
- 52 If We Make it Through December
- 53 In the Pines
- 54 Just to Ease My Worried Mind
- 55 Keep on the Sunny Side
- 56 Last Train from Poor Valley
- 57 Life's Railway to Heaven
- 58 Little Cabin Home on the Hill
- 59 Little Georgia Rose
- 60 Little Liza Jane
- 61 Little Maggie
- 62 Little Sadie

63	Lonestar	96	Sitting on Top of the World
64	Long Black Veil	97	Six Days on the Road
65	Look at Miss Ohio	98	Sunny Side of the Mountain
66	Louise	99	Sweet Dreams
67	Lovesick Blues	100	Sweet Sunny South
68	Make Me a Pallet on Your Floor	101	Swing Low Sweet Chariot
69	Make the World Go Away	102	Swingin' Doors
70	Making Believe	103	Take this Hammer
71	Man of Constant Sorrow	104	Tennessee Waltz
72	Midnight Special	105	That's Alright Mama
73	Mister Bojangles	106	This Land is Your Land
74	My Grandfather's Clock	107	This Train
75	Nine Pound Hammer	108	Together Again
76	O Death	109	Turn Your Radio On
77	Oklahoma Hills	110	Uncle Pen
78	Old Home Place	111	The Unclouded Day
79	On and On	112	Waiting for a Train
80	On the Road Again	113	Walkin' Down the Line
81	One More Dollar	114	Walkin' in My Sleep
82	Orange Blossom Special	115	We're All in This Thing Together
83	Pan American	116	When the Saints Go Marchin' In
84	Paradise	117	Whiskey in the Jar
85	The Race is On	118	White Freightliner
86	Rain and Snow	119	Wild Horses
87	Rank Strangers	120	Wild Side of Life
88	Red Rockin' Chair	121	Wildwood Flower
89	Red Wing	122	Will the Circle be Unbroken
90	Roll in My Sweet Baby's Arms	123	With Body and Soul
91	Ruby	124	Workin' Man Blues
92	Satin Sheets	125	Wreck of Old 97
93	Shady Grove	126	You Ain't Goin' Nowhere
94	She Thinks I Still Care	127	You Are My Sunshine
95	Sing Me Back Home	128	You Win Again

ALABAMA JUBILEE

JACK YELLEN AND GEORGE COBB

Intro: C E7 F C D7 G7 C

Strum=dD

First note = A

Walk down C B Bb A chords or single notes C B Bb A down

A

You ought to see Deacon Jones when he rattles 'dem bones

D

Old Parson Brown dancing 'round like a clown

G

Old Aunt Jemima, she's past ninety-three

C

Shouting out full of pep

C

C B Bb

Watch your step, watch your step

A

One legged Joe spins around on his toe

Dm

Throws away his crutch and hollers

D7

Let her go

C E7 F C

Oh, honey hail, hail, the gang's all here

D7 G7 C

At the Alabama Jubilee

Solo over chords above then repeat all above C G C finish

Solo	A7	D	G	
A	-3-2-1-0-----0-----0-	-0-----0-----0-----0-	-2-2--0-----0-----0-2-	
E	-----3-0---3-0---3-0---	---2-----2-----2-----	-----3---3-3---3-----	
C	-----	---2-----2-----2-----	-----	
G	-----	-----	-----	
A	---0-2-3-2-3-0-----	-----3-4-	-0-----0-----0-----0-	-----
E	-3-----3-0-	-----3-4-	---3-0---3-0---3-0---	-----0-1-0-1-3-
C	-----	-0---0-	-----	-2-1-2-
G	-----	---4---2-	-----	-----
A	-0---0-2-3-	-2-3-2-3-5-7-7-	-5-----	----- -7-3-
E	---3-----	-----	---8-5-	-5---5-6-7-
C	-----	-----	---7-6-7-	---8-----
G	-----	-----	-----	-----

ALMOST PERSUADED

BILLY SHERRILL & GLENN SUTTON

Lefty Frizell Daxid Houston

Intro: G D G

Strum D D UD

First note=G

G G7 C
 Last night all alone in a barroom
 G D
 Met a girl with a drink in her hand
 G G7 C
 She had ruby red lips, coal black hair
 G D G
 And eyes that would tempt any man.

G G7 C
 Then she came and sat down at my table
 G D
 And as she placed her soft hands in mine
 G G7 C
 I found myself wanting to kiss her
 G D G
 For temptation was flowing like wine.

Solo

G G7 C
 And I was almost persuaded
 G D
 To strip myself of my pride
 G G7 C
 almost persuaded
 G D G E (modulate to A)
 To push my conscience aside.

A A7 D
 Then we danced and she whispered, "I need you,
 A E7
 Take me away from here and be my man."
 A A7 D
 Then I looked into her eyes and saw it
 A E7 A
 The reflection of my wedding band.

A A7 D
 And I was almost persuaded
 A E7
 To let strange lips lead me on
 A A7 D
 Almost persuaded
 A E7 A D A
 But your sweet love made me stop and go home

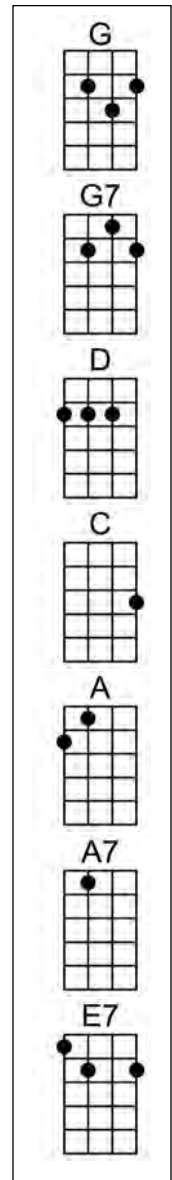

Solo	
A	-----0-2-0----- -----0-2---
E	---3---3-1-3-1-1-0- -3---3-3-----
C	-2-----2-2-----0- ---2-----2-
G	-----0-0-----0- ---0-----2-
A	-7-5-2-0----- -----0-----
E	-7-----3-3-1-1-0- -3---3-2-3-2-3-
C	-7-----2-----0- ---2---2-----2-
G	-7-----0-----0- ---0---2-----0-

ALWAYS LATE

LEFTY FRIZZEL

Intro: A D A

Strum=D DU UD

First note=E

Chorus

A D A
Always late with your kisses

E7
Won't you come to my arms sweet darling and stay

A D A
Always late with your kisses

E7 A
Why oh why do you want to do me this way

A7 D A
How long do you think I can wait

B7 E7
When you know you're always late

A D A
Always late with your kisses

E7 A
Why oh why do you want to do me this way

A D A
Always late with your kisses

E7
Won't you come to my arms sweet darling and stay

A D A
Always late with your kisses

E7 A
Why oh why do you want to do me this way

Solo

Chorus

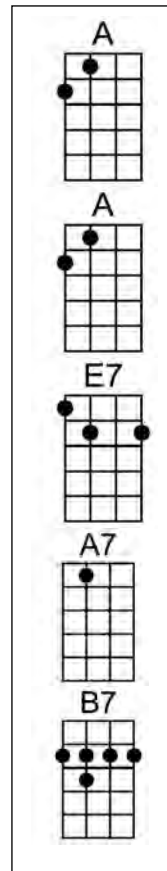

Solo			
A	---4-----	-4-4-4-4-4-----4---	-----
E	---5---5---	-----7-5---7-	---7-5-----5-----
C	-4-----6---4---	-----	-4-----4-5-6---4---
G	-----6-	-----	-----6-

AMAZING GRACE

JOHN NEWTON

Intro: C G C

Strum= D DU UD

First note=G

G G7 C G
 Amazing grace, how sweet the sound,
 G Em D D7
 That saved a wretch like me!
 G G7 C G
 I once was lost, but now am found,
 Em D G
 Was blind but now I see.

G G7 C G
 Through many dangers, toils and snares,
 G Em D D7
 I have already come.
 G G7 C G
 'Tis grace hath brought me safe thus far,
 Em D G
 And grace will lead me home.

G G7 C G
 And when this flesh and heart shall fail,
 G Em D D7
 And mortal life shall cease,
 G G7 C G
 I shall possess with the veil
 Em D G
 A life of joy and peace.

Solo – harp or uke (could also start fret 7 string 2)

G G7 C G
 When we've been there ten thousand years,
 G Em D D7
 Bright shining as the sun.
 G G7 C G
 We've no less days to sing God's praise,
 Em D G C G
 Than when we'd first begun.

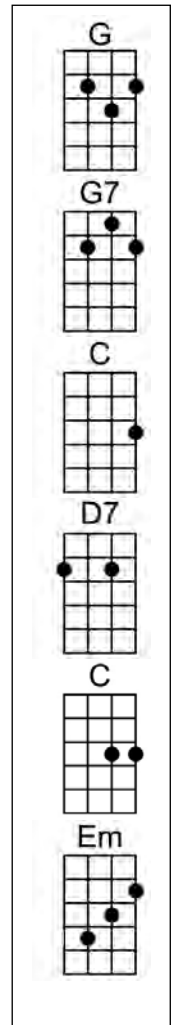

Solo				
A	-----	-----	-----	-----
E	----0--0--	-----	----0--0--	---3---
C	--0---0---	2-0-----	--0---0---	2-----
G	0-----	---2-0-	0-----	-----
A	-----	-----	-----	-----
E	0-3-3-0--	-----	--0---0--	-----
C	-----0-	---0-----	--0---0---	2-0-0-
G	-----	0-2--2-0-	0-----	-----

ANGEL BAND

HASCALL & BRADBURY

Stanley Brothers

First note = D

Intro: G D G

Strum =D DUD

G C G
 My latest sun is sinking fast
 G D G
 My race is nearly run
 G C G
 My strongest trials now are past
 G D G
 My triumph has begun

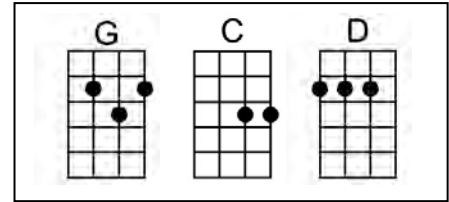

Chorus

D G
 Oh come angel band
 D G
 Come and around me stand
 C G
 Oh bear me away on your snow white wings
 G D G
 To my immortal home
 C G
 Oh bear me away on your snow white wings
 G D G
 To my immortal home

Chorus			
A	-0-0-2-0-	-----0-----	---0---0-2-0---
E	-----3-	---0-3-3---3-0---3-3-	-3---3-----3-
C	-----	-2-----2-----	-----
G	-----	-----	-----

G C G
 I've almost gained, my heavenly home
 G D G
 My spirit softly sings
 C G
 Behold they come, the holy ones
 G D G
 I hear the sound of wings

Chorus

C G
 Oh bear me away on your snow white wings
 G D G
 To my immortal home

ANNABELLE

GILLIAN WELCH

Intro Am F C G Am F E7 Am Strum D DU UDU

First note=G

Am F
 We lease twenty acres and one Ginny mule
 E7 Am
 From the Alabama trust
 Am F
 For half of the cotton and a third of the corn
 E7 Am
 We get a handful of dust

F C G Am
 We cannot have all things to please us, no matter how we try
 F C G Am F C G Am F E7
 Until we've all gone to Jesus, we can only wonder why

Am F
 I had a daughter called her Annabelle
 E7 Am
 She's the apple of my eye
 Am F
 Tried to give her something like I never had
 E7 Am
 Didn't want to ever hear her cry

F C G Am
 We cannot have all things to please us, no matter how we try
 F C G Am F C G Am F E7
 Until we've all gone to Jesus, we can only wonder why

Solo over verse chords

Am F
 When I'm dead and buried I'll take a hard life of tears
 E7 Am
 From every day I've ever known
 Am F
 Anna's in the churchyard she got no life at all
 E7 Am
 She only got these words on a stone

Solo			
A	-----0-0-----	-----	
E	-0-3-----3-0-3-	-----0-----	
C	-----	-0-2---2-0---	
G	-----	-----2-	...

F C G Am
 We cannot have all things to please us, no matter how we try
 F C G Am F C G Am F E7
 Until we've all gone to Jesus, we can only wonder why

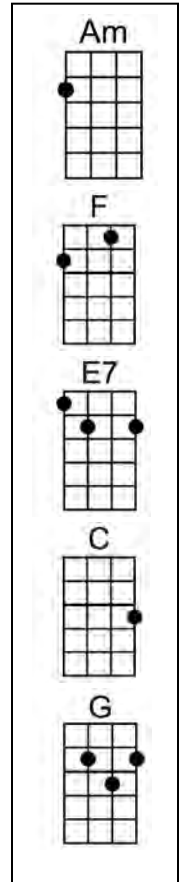

BLUE EYES CRYIN' IN THE RAIN

WILLIE NELSON

Intro: D

Strum =D DU UD

First note = F#

D (single notes C# D D#)
 In the twilight glow, I see
 A D
 Blue eyes cryin' in the rain
 D (C# D D#)
 When we kissed goodbye and parted
 A D (D D# E F#)
 I knew we'd never meet again

Picking pattern D
 A |-----0-----|
 E |-----2-----2-|
 C |---2-----2---|
 G |-2-----2-----|
 Find melody from chords

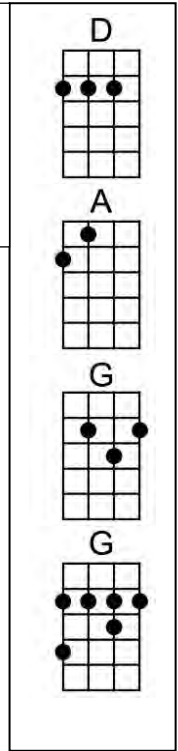

Bridge

G (B A G)
 Love is like a dying ember
 D A (G A A G F# E)
 Only memories remain.
 D
 And through the ages I'll re-member
 A D
 Blue eyes cryin' in the rain.

Solo over verse - Use chord shapes

Solo	D	
A	-----0-----	-----0-----
E	-----0-2h3-2---3-2---	-----5-4-3-5-3---3-2---
C	---2---2-----2-----2-	---6-5-4-----2-----
G	-2-----2-----2-----	-----2-----
	D	A D
A	-----2-----	-----2-----
E	-----2-2h3-2---3-2---	-----2-0---0-2-0---0---
C	---2-----2-----2-----	-----2-----1---2---
G	-2-----2-----2-----	-----2-----2-----

Bridge2

G (B A G)
 Someday when we meet up yonder,
 D A (G A A G F# E)
 We'll stroll hand in hand again.
 D (G G# A)
 And in a land that knows no parting,
 A D G D A D
 Blue eyes cryin' in the rain (or arpeggio DGD)

Outro	D	G	D	D
A	-----0-----	-----0-----	-----0-5---	
E	-----2-----	-----3-----	-----2---2---	
C	---2-----2-----	-----2-----	-----2-----	
G	-2-----2-4-----	-----4-2-----	-----2-----	

BLUE MOON OF KENTUCKY

BILL MONROE

Intro: C G7 C or below

Strum=dD dD dD dD

First note=G

C F
 Blue moon of Kentucky keep on shining
 C G7
 Shine on the one that's gone and left me blue
 C F
 I said blue moon of Kentucky keep on shining
 C G7 C C7
 Shine on the one that's gone and left me blue

F C
 It was on one moonlight night stars shining bright
 F C G7
 Whisper on high love said goodbye
 C F
 Blue moon of Kentucky keep on shining
 C G7 C
 Shine on the one that's gone and left me blue

C F
 Blue moon of Kentucky keep on shining
 C G7
 Shine on the one that's gone and left me blue
 C F
 I said blue moon of Kentucky keep on shining
 C G7 C
 Shine on the one that's gone and left me blue

F C
 It was on one moonlight night stars shining bright
 F C G7
 Whisper on high love said goodbye
 C F
 Blue moon of Kentucky keep on shining
 C G7 C G7 C
 Shine on the one that's gone and left me blue

Intro	C
A	-----3--
E	-0-1-2-3--
C	-0-2-3-0--
G	-----0--

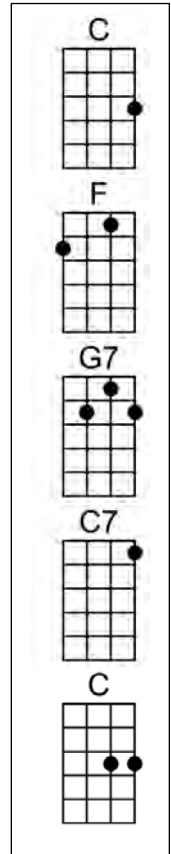

BYE BYE LOVE

FELICE & BOUDLEAUX BRYANT

Everly Brothers

Intro: D D F G x2

Strum DD D DU UD

First note=G

Chorus

G D G D
Bye bye love, bye bye happiness
G D A D
Hello loneliness, I think I'm-a gonna cry

G D G D
Bye bye love, bye bye sweet caress
G D A D
Hello emptiness, I feel like I could die
D A D
Bye bye my love goodbye

N.C. A D
There goes my baby with someone new
A D D7
She sure looks happy, I sure am blue
G A
She was my baby till he stepped in
D D7
Goodbye to romance that might have been

Chorus

N.C. A D
I'm through with romance, I'm through with love
A D7
I'm through with countin' the stars above
G A
And here's the reason that I'm so free
D D7
My lovin' baby is a through with me

Chorus

Outro to fade

D A D
Bye bye my love goodbye

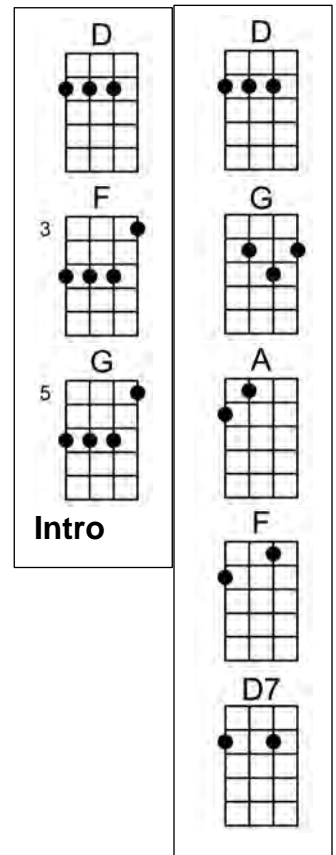

CALIFORNIA BLUES

BLUE YODEL NO. 4

JIMMIE RODGERS

First note=E

C **C7**
Well I'm goin' to California, where they sleep out every night
F **F7** **C**
I'm goin' to California where they sleep out every night
G7 **C**
I'm leaving you mama cause you know you don't treat me right

C **C7**
Let me tell you something, mama that you don't know
F **F7** **C**
Let me tell you something, good gal that you don't know
G7 **C**
Well I'm a do-right pappa and got a home everywhere I go

CHORUS

C
I got the California blues and I'm sure gonna leave you here Lawd Lawd
F **F7** **C**
I got the California blues and I'm sure gonna leave you here
G7 **C**
I may ride the blinds, I ain't got no railroad fare

C **C7**
Listen to me mama while I sing this song
F **F7** **C**
Listen to your daddy sing you this so lonesome song
G7 **C**
You got me worried now but I won't be worried too long.

Intro- also at end of chorus/song or yodel / =slide into note

A	-----7-	-----5----	-----3-	-----	-3-
E	-----	-----	-3-5-3-	-----	-3-
C	-4-5---	-/4/-5-3-/4-	-----	-3-4---	-4-
G	-----	-----	-----	-5-	-5-

Chorus

A	-----	-0-1-0-	-----	-----	-----	-----
E	-0-3-0-3-0-3-0-3	-----	-3-	-----	-3-	-3-3-----
C	-----	-----	/4-0	-----	-0-2-0-3-2-0	-0-2-0---2-0
G	-----	-----	-0-1-2-	-----	-----	-----

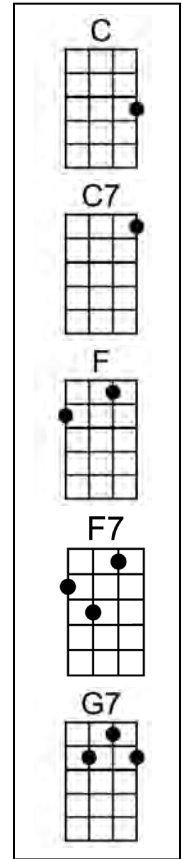

CARELESS LOVE

TRADITIONAL

Intro: F C F or below

Strum =D DU UD

First note =A

Chorus

F C F
 Love oh love oh careless love
 F C
 Love oh love oh careless love
 F F7 Bb Bbm6
 Love oh love oh careless love
 F C7 F
 See what love done to me

Intro			F
A	-----0-- -----	-0-	
E	-3-4- -1-0--0-3-	-1-	
C	----- -----	-0-	
G	----- -----	-2-	

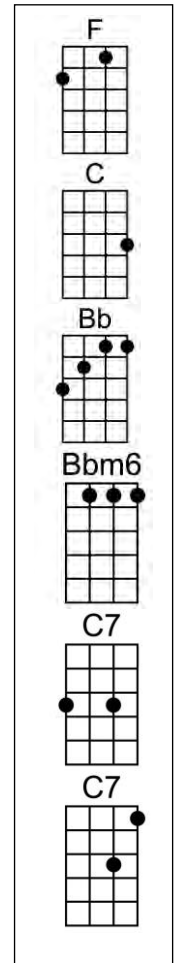

F C F
 Well it's sorrow, sorrow to my heart
 F C
 Well it's sorrow, sorrow to my heart
 F F7 Bb Bbm6
 Well it's sorrow, sorrow, sorrow, to my heart
 F C F
 Since me and my true love had to part

Chorus

F C7 F
 It tied me to your apron string
 F C7
 It tied me to your apron string
 F F7 Bb Bbm6
 You said that you loved me and it didn't mean a thing
 F C7 F
 It was love oh love oh careless love

F C
 I wish the lord my train would come
 F C
 I wish the lord my train would come
 F F7 Bb Bbm6
 I wish the lord my train would come
 F C F
 And take me back where I come from

Chorus

COPPER KETTLE

Intro below or Em Am Dm G

Strum D DU DD

C G C
Get you a copper kettle
C G C
Get you a copper coil
Em Am
Fill it with new-made corn mash
Dm G
And never more we'll toil

Chorus

Am Em
We just lay there by the juniper
Am C Em
while the moon shines bright
Am G
Watch those jugs a-filling
Am Em Am
In the pale moonlight

C G C
Build you a fire with hickory
C G C
Hickory, ash and oak
Em Am
Don't use no green or rotten wood
Dm G
They'll get you by the smoke

Chorus

C G C
My daddy, he made whiskey
C G Am
My grand-daddy, he did too
Em Am
We ain't paid no whiskey tax
Dm G
Since seventeen ninety-two

FRANK BEDDOE

First note=C

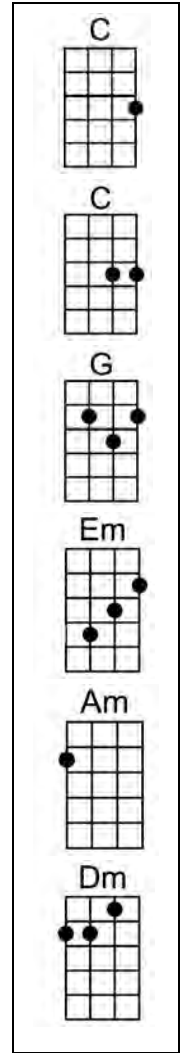

Chorus

Intro	A	-----0-0-0-0-----	-0-0-----	-0-0-0-0-----	-----
E		-0-3-----3---	-----3-0-----	-----3---	-----0-----
C		-----0-	-----2-0-	-----0-	-2-0-2---2-0---
G		-----	-----	-----	-----2-

14

COUNTRY ROADS

JOHN DENVER

Intro: below then G

G Em
 Almost heaven, West Virginia
 D C G
 Blue Ridge Mountains, Shenandoah River
 G Em
 Life is old there, older than the trees
 D C G
 Younger than the mountains, blowing like a breeze

Chorus

G D
 Country roads, take me home
 Em C
 To the place, I belong
 G D
 West Virginia, mountain momma
 C G
 Take me home, country roads

G Em
 All my mem'ries, gather 'round her
 D C G
 Miner's lady, stranger to blue water
 G Em
 Dark and dusty, painted on the sky
 D C G
 Misty taste of moonshine, teardrops in my eyes

Chorus

Em D G
 I hear her voice, in the mornin' hours she calls to me
 C G D
 The radio reminds me of my home far away
 Em F C G
 And drivin' down the road I get a feeling that I should have been home
 D D7
 yesterday, yesterday

Chorus

G D G C G
 Tag Take me home, country roads

Strum D DU UD

Intro	
A	----- -----7-----
E	-6/7- -10---7---
C	----- -----7---
G	----- -----

First note=D

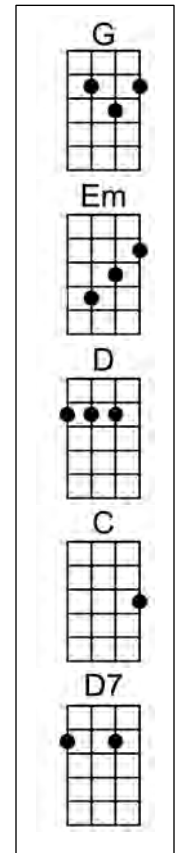

CRAZY

WILLIE NELSON

Intro: F Em Dm G

Strum= D DU UD

First note=D#

C A A7 Dm
 Crazy, I'm crazy for feeling so lonely
 G7 G7sus4 C Cdim Dm7 G7
 I'm crazy, crazy for feeling so blue
 C A A7 Dm
 I knew you'd love me as long as you wanted
 G7sus2 G7 C F#9 F9 D7
 And then someday, you'd leave me for somebody new
 F C
 Worry, why do I let myself worry?
 D7 G7 Dm7 G7
 Wond'ring what in the world did I do?
 C A A7 Dm
 Crazy for thinking that my love could hold you
 F Em Dm7 Em Em6 C#dim7
 I'm crazy for trying and crazy for crying
 F G7 C Fm CM7
 And I'm crazy for loving you

Melody

A	----- -----0-----0- -0-0-----3- -0-2----
E	----- -----0---3-0-1-- -----1--- -----3-
C	-3-4--- ---1----- -----2----- -----
G	----0- -2----- -----4-2-0- -----

A	----- -----0-----0- -0-0----- -----
E	----- -----0---3-0-1-- -----1--- -0-----
C	-3-4--- ---1----- -----2----- ---2-0-
G	----0- -2----- -----4-2-0-4- -----

A	-3-0-----0-3-2-0-3--- -3-0-----0-3-2-0- -2-0-2-0----
E	-----1-----3- -----2----- -----3-
C	-----0----- -----2----- -----
G	----- ----- -----

A	----- -----0-----0- -2-3-0---2--- ---3-2-0----
E	----- -----0---3-0-1-- -----1---3- -3-----3-0-
C	-3-4--- ---1----- ----- -----
G	----0- -2----- ----- -----

A	----- ----- -3--3--7-
E	--0-1--- --0-0--- -0--1--7-
C	-2----- -----0- -0--0--7-
G	-----2- -0----- -0--1--5-

CRIPPLE CREEK (AKA SHOOTIN' CREEK)

TRADITIONAL

Intro: C G C Strum =dD dD dD dD

First note =C

C F C
I got a gal at the head of the creek
C G C
goin up to see her bout the middle of the week
C F C
Kiss her on the mouth just as sweet as wine
C G C
wraps herself around me like a sweet potato vine

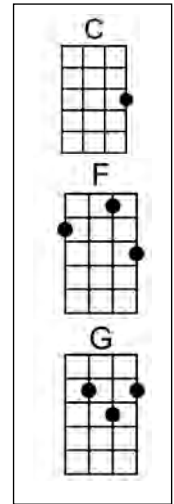

Chorus

C F C
Goin' up Cripple Creek goin' in a run
C G C
Goin' up Cripple Creek to have some fun.
C F C
Goin' up cripple creek goin in a whirl
C G C
Goin' up Cripple Creek gonna see my girl

Instrumental verse

Instrumental chorus

C F C
I went down to Cripple Creek
C G C
To see what them girls had to eat
C F C
I got drunk and fell against the wall
C G C
Old corn likker was the cause of it all

C F C
I got a girl and she loves me
C G C
She's as sweet as sweet can be
C F C
She's got eyes of baby blue
C G C
And her love for me is true.

Chorus

C F C
Girls up cripple creek 'bout half grown
C G C
jump on a man like a dog on a bone
C F C
Roll my breeches to my knees
C G C
I'll wade ol' Cripple Creek when I please

Chorus

repeat Chorus

Chorus

C F C
Cripple Creek's wide and Cripple Creek's deep
C G C
I'll wade old Cripple Creek before I sleep
C F C
Hills are steep and the road is muddy
C G C
And I'm so drunk, I can't stan' steady
Chorus

Verse				
A	-3-3-----	---0---	-----	-----
E	-----3-0-	-1---3-	-0-0-----	-----
C	-----	-----	-----2-0-0-	--0-0-
G	-----	-----	-----	-2-----

Chorus				
A	-----	-----	-----	-----
E	-----	-----	-----	-----
C	-2-/4-2p0-	-2-/4---	-2-/4-2p0-	--0-0-
G	-----	-----0-	-----	-2-----

DARK AS A DUNGEON

MERLE TRAVIS

Intro: A or below

Strum= dDD or D DUD

First note=A

A D E7
Come all you young fellers, so young and so fine
A D A
And seek not your fortunes win the dark dreary mine
A D E7
It will form like a habit and seep in your soul
A D A
'Til the stream of your blood flows as black as the coal

Intro	A
A	-----0-
E	-----0-
C	---1-----
G	---2-----

The diagrams show the following fingerings:
 A: 2nd fret, 4th string; 2nd fret, 5th string.
 D: 2nd fret, 2nd string; 3rd fret, 3rd string; 2nd fret, 4th string; 2nd fret, 5th string.
 E7: 1st fret, 2nd string; 2nd fret, 3rd string; 2nd fret, 4th string; 2nd fret, 5th string.
 A: 2nd fret, 4th string; 2nd fret, 5th string.

Chorus

E7 D A
It's dark as a dungeon and damp as the dew
E7 D A
Where the dangers are double and the pleasures are few
A D E7
Where the rain never falls and the sun never shines
A D A
It's dark as a dungeon way down in the mines

Chorus, Solo

A D E7
There is many a man I have known in my day
A D A
Who lived just to labor his whole life away
A D E7
Like the fiend with his dope and the drunkard his wine
A D A
A man will have lust for the lure of the mine

Chorus

A D E7
I hope when I'm gone and the ages shall roll
A D A
That my body will blacken and turn into coal
A D E7
Then, I'll look from the door of my heavenly home
A D A
And pity the miner a' diggin' my bones

Chorus

Solo on verse melody				
A	-----	-----0-0-2-	-0-4-4-2-0-	-----0-
E	-----0-	-0-2-----	-----0-	-0-2-2-0-
C	---1-----1-	-----	-----	-----
G	---4-2-2-	-----	-----	-----
A	-----	-----0-0-2-	-0-4-4-2-0-	-----0-2-
E	-----0-	-0-2-----	-----0-	-0-2-2-0-
C	---1-----1-	-----	-----	-----
G	---4-2-2-	-----	-----	-----

DARK HOLLOW

BILL BROWNING

Walkup below

Strum=D DU UD or dD dD dD dD

First note=B

G D G
I'd rather be in some dark hollow

G C G
Where the sun don't ever shine

G G7 C
Than to be home alone knowing that you're gone

G D G
Would cause me to lose my mind

G D G
So blow your whistle freight train

G C G
Carry me further on down the track

G G7 C C7
I'm going away, I'm leaving today

G D G
I'm going, but I ain't coming back

G D G
I'd rather be in some dark hollow

G C G
Where the sun don't ever shine

G G7 C
Then to be in some big city,

G D G
In a small room, with you on my mind

Solo

G D G
So blow your whistle freight train

G C G
Carry me further on down the track

G G7 C C7
I'm going away, I'm leaving today

G D G
I'm going, but I ain't coming back

G D G
I'd rather be in some dark hollow

G C G
Where the sun don't ever shine

G G7 C
Then to see you another mans darlin',

G D G
And to know that you'll never be mine

Walkup to G

A	-----2-
E	-----3-
C	---0-1-2-2-
G	-4-----

Picking pattern G

A	-2-----2-----
E	-----3-----3-
C	-----2-----2-
G	-0-----0-----

Solo

A	----- -----
E	----- ---5-7-5-----
C	-----4-----7- -7-----7-4-
G	-4-5-6-7---7-7-7- -----7-
A	-----5----- ----- -----
E	---5-7---7-5- ----- -----
C	-7----- -7-7-4-7- -4-----
G	----- ----- ---7-4-7-2/4-0-

DARLIN' COREY

TRADITIONAL

Intro: below

A G
 Wake up, wake up, darling Corey..
 A G A
 what makes you sleep so sound?
 G
 The revenue officers are coming,
 A G A
 they're gonna tear your stillhouse down.

A G
 Well, the first time I seen darling Corey,
 G A
 she was sitting by the banks of the sea.
 G
 Had a .44 strapped around her body.
 A G A
 and a five-string banjo on her knee.

A G
 Go away, go away, darling Corey.
 G A
 Quit hanging around my bed.
 G
 Your liquor has ruined my body,
 A G A
 pretty women gone to my head.

A G
 Dig a hole, dig a hole, in the meadow.
 A G A
 Dig a hole in the cold damp ground.
 G
 Dig a hole, dig a hole, in the meadow,
 A G A
 we're gonna lay darling Corey down.

A G
 Can't you hear them bluebirds a-singing?
 A G A
 Don't you hear that mournful sound?
 A G
 They're preaching darling Corey's funeral,
 A G A
 in some lonesome graveyard ground.

Strum= dD or D DU UD First note=G

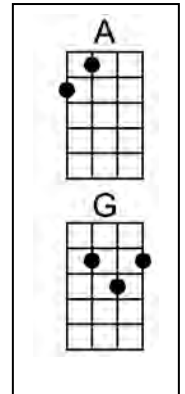

Melody				
A	-----0-0-	-3-0-----0-	---0-0-0-	-----
E	-3-5-----	-----0-3---	-0-----	-3-----
C	-----	-----	-----	---2-0---
G	-----	-----	-----	-----2-
A	-----	-----0-	-----0-0-	-----
E	-0-----	---0-0-0-0-3---	-0-3-----0-	-----
C	-----	-0-----	-----2-0-	-----
G	---2-2-2-	-----	-----	-----2-

DIM LIGHTS, THICK SMOKE (AND LOUD, LOUD MUSIC)

JOE MAPHIS, ROSE LEE MAPHIS AND MAX FIDLER

Lefty Frizell Daxid Houston

Intro: D A7 D or below

Strum D DU UD

First note=A

Chorus

D G
Dim lights thick smoke and loud, loud music
D A7
Is the only kind of life you'll ever understand
D G
Dim lights thick smoke and loud, loud music
D A7 D
You'll never make a wife to a home lovin' man

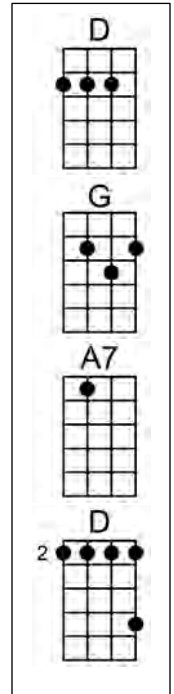

D G
A home and little children mean nothing to you
D A7
A house filled with love and a husband so true
D G
You'd rather have a drink with the first guy you meet
D A7 D
And the only house you know is the club down the street

Chorus

	Intro D	G	D	D
A	-0-0--0-----0-2-0---	-0-0-0-0-0-----	-----	-5-
E	---2-----2-----3-3-	---2-----0h2-2-0-2p0---	-----	-2-
C	---2-----2-----2---	---2-----2-----	-----	-2-
G	---2-----0---	---2-----	-----	-2-

D G
A-drinkin' and a-dancin' to a honky-tonk band
D A7
Is the only kind of life you'll ever understand
D G
Go on and have your fun, you think you've played it smart
D A7 D
I feel sorry for you and your honky-tonk heart

Chorus

D G
Dim lights thick smoke and loud, loud music
D A7
Is the only kind of life you'll ever understand
D G
Dim lights thick smoke and loud, loud music
D A7 D D G D
You'll never make a wife to a home lovin' man

DON'T LET YOUR DEAL GO DOWN

TRADITIONAL

Charlie Poole
First note=A

Intro: Walkdown 1st string C B A# A

Strum DD DD DD DD

A7 D7 G7 C
 Oh I've been all around this whole wide world, down to sunny Tennessee
 A7 D7 G7 C
 Any old place I hang my hat looks like home to me

Chorus

A7 D7 G7 C
 Don't let your deal go down, don't let your deal go down
 A7 D7 G7 C
 Don't let your deal go down 'till your last gold dollar is gone

A7 D7 G7 C
 Last time I seen that gal of mine, she was standin' in the door,
 A7 D7
 She threw her little arms around my neck and said,
 G7 C
 "Sweet daddy please don't go."

Chorus x 2

A7 D7 G7 C
 Now it's who's gonna shoe your pretty little feet? Who's gonna glove your hand?
 A7 D7 G7 C
 And who's gonna kiss your ruby red lips - Honey, who's gonna be your man?

Chorus

A7 D7 G7 C
 She says, "Papa will shoe my pretty little feet, Mama will glove my hand,
 A7 D7 G7 C
 You can kiss my ruby red lips when you get back home again."

Chorus

A7 D7 G7 C
 Where did you get them high-heel shoes and that dress you wear so fine?
 A7 D7 G7 C
 Got my shoes from a railroad man, dress from a driver in the mine.

Chorus

A7 D7 G7 C
 Now I've been all around this whole wide world, done most everything
 A7 D7 G7 C
 I've played cards with the King and the Queen, discard the ace and the ten

Chorus

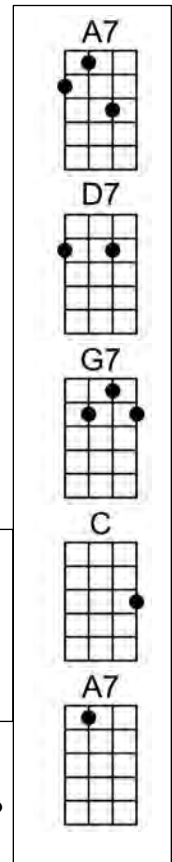

Picking pattern A7	
A	-----2-----
E	-----3-----3-
C	---1-----1---
G	-2-----0-----

DOWN TO THE RIVER TO PRAY

TRADITIONAL

Can do all or first verse acapella

Strum D DU UD

First note=B

G D G
I went down in the river to pray, learnin' about the good old way
D C D
And who would wear the starry crown, Good Lord, show me the way

D G
Oh Brother, let's go down, lets go down
C G
Come on down, don't you want to go down
D G C
Oh Brother, let's go down, down in the river to pray

G D G
As I went walkin' in the valley to pray, learnin' about the good old way
D C D
And who would wear the starry crown. Oh Lord, show me the way

D G
Oh Father, let's go down, lets go down
C G
Come on down, don't you want to go down
D G C
Oh Father, let's go down, down in the river to pray

G D G
I went out walkin' on the mountain to pray, learnin' about the good old way
D C D
I went up on the mountain and I just had to say, Oh Lord, show me the way

D G
Oh Sister, let's go down, let's go down
C G
Come on down, don't you want to go down
D G C
Oh Sister, let's go down, down in the river to pray

G D G
As I went down in the river to pray, studyin' about the good old way
D C D
And who will wear the starry crown, Oh Lord, show me the way

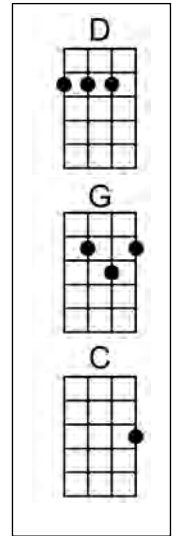

ELVIS PRESLEY BLUES

GILLIAN WELCH

Intro

Strum D DU UDU

First note=A

G G7
I was thinking that night about Elvis, day that he died, day that he died

G G7
I was thinking that night about Elvis, day that he died, day that he died

G
Just a country boy that combed his hair, put on a shirt his mother made and went on the air

Em G Em G
And he shook it like a chorus girl and he shook it like a Harlem queen

Em G C G
He shook it like a midnight Rambler, baby, like you never seen

G G7
I was thinking that night about Elvis, day that he died, day that he died

G G7
I was thinking that night about Elvis, day that he died, day that he died

G
How he took it all out of black and white

C C
Grabbed his wand in the other hand and he held on tight

Em G Em G
And he shook it like a hurricane and he shook it like to make it break

Em G C G
And he shook it like a holy roller, baby with his soul at stake, with his soul at stake

G G7
I was thinking that night about Elvis, day that he died, day that he died

G G7
I was thinking that night about Elvis, day that he died, day that he died

G
He was all alone in a long decline

C G
Thinking how happy John Henry was that he fell down and died

Em G Em G
When he shook it and he rang like silver and he shook it and he shine like gold

Em G C G G7
He shook it and he beat that steam drill, baby, well bless my soul, bless my soul

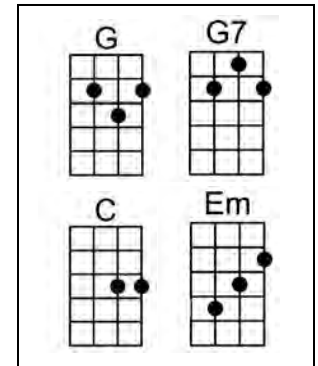

Repeat first verse

A FEAST HERE TONIGHT

TRADITIONAL

Bill Monroe

First note=A

Strum dD dD dD dD

Intro: D G D
D

There's a rabbit in the log and I ain't got my dog
A7

How will I get him I know
D

I'll get me a briar and twist it in his hair
A7 D

That way I'll get him I know

G D
I know (yes I know) I know (I surely know)
A7

That's how I'll get him I know
D

I'll get me a briar and twist in his hair
A7 D

That way I'll get him I know

D
I'll build me a fire and I'll cook that old hare
A7

Roll him in the flames good and brown

D
Have a feast here tonight while the moon is shining bright

A7 D
And find me a place to lie down

G D
To lie down (to lie down) to lie down (to lie down)
A7

Find me a place to lie down
D

Have a feast here tonight while the moon is shining bright

A7 D
And find me a place to lie down

Solo if desired

D
I'm going down that track got my coat on my back
A7

Soles on my shoes are nearly gone
D

A little ways ahead there's an old farmer's shed
A7 D

That's where I'll rest my weary bones

G D
Weary bones (weary bones) weary bones (you lazy bones)
A7

That's where I'll rest my weary bones
D

A little way's ahead there's a farmer's shed
A7 D

That's where I'll rest my weary bones

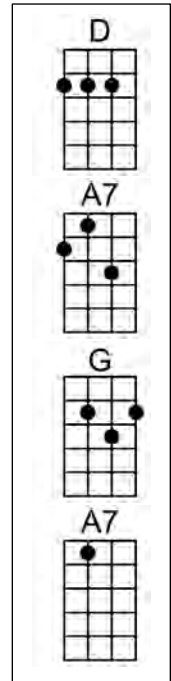

FOLSOM PRISON BLUES

GORDON JENKINS -JOHNNY CASH

G
 I hear the train a comin' it's rollin 'round the bend
G7
 and I a'int seen the sunshine since I don't know when
C **G**
 I'm stuck in Folsom Prison, and time keeps draggin' on.
D7 **G**
 But that train keeps a movin' on down to-San-an-tone

G
 When I was just a baby my mama told me, "Son
G7
 Always be a good boy, don't ever play with guns"
C **G**
 But I shot a man in Reno, just to watch him die
D7 **G**
 When I hear that whistle blowin' I hang my head and cry.

Solo
G
 I'll bet there's rich folks eatin' in some fancy dining car
G7
 Probably drinkin' coffee and smokin' big cigars
C **G**
 Well I know I had it comin' I know I can't be free
D7 **G**
 But those people keep a movin' that's what tortures me

G
 Well, if they freed me from this prison, if that railroad train was mine
G7
 I bet I'd move it on, a little further down the line
C **G**
 Far from Fulsom Prison, that's where I want to stay
D7 **G**
 And I'd let that lonesome whistle, blow my blues away

First note=G

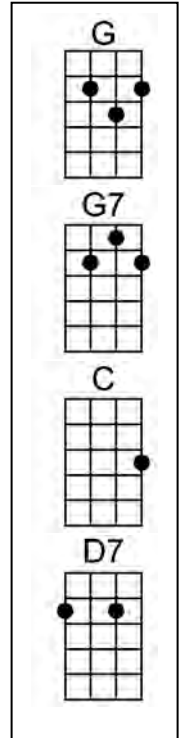

Intro:	G	Outro:	G
A	-----2-	-----2-	
E	-----2-2-----3-	-----2-2-----3-	
C	-2-2-2-----2-----2-	-----2-2-----2-----2-	
G	-----3p2-0-0-	-----3p2-0-0-	

Solo:

A	-----5-8-5-8-5-	-----5-8-5-8-	-----5-8-5-8-5-	-----5-8-5-8-5-
E	-6-7-----	-6-7-----	-6-7-----	-6-7-----7-
C	-----	-----	-----	-----7-
G	-----	-----	-----	-----

C	G	D	C Bb	G
A	-7---4 Bars---	-5---4 Bars---	-5--3 Bars -3--1-	-2-----
E	-8-----	-7-----	-5-----3--1-	-3-----
C	-7-----	-7-----	-6-----4--2-	-2-----
G	-9-----	-7-----	-7-----5--3-	-0-----

FOOTPRINTS IN THE SNOW

HARRY WRIGHT

Bill Monroe
First note =G

Intro: C G C

Strum =dD dD dD dD

C F
Some folks like the summer time when they can walk about
G7 C
Strolling through the meadow green it's pleasant there no doubt
F
But give me the winter time when snow is on the ground
G7 C
For I found her when the snow was on the ground

Chorus

C G7
I traced her little footprints in the snow
C
I found her little footprints in the snow
F
Bless that happy day when Nellie lost her way
G7 C
For I found her when the snow was on the ground
F
I dropped in to see her there was a big round moon
G7 C
Her mother said she just stepped out but would be returning soon
F
I found her little footprints and traced them through the snow
G7 C
For I found her when the snow was on the ground

Chorus

F
Now she's up in heaven she's with the angels band
G7 C
I know I'm going to meet her in that promised land
F
Every time the snow falls it brings back memories
G7 C
For I found her when the snow was on the ground

Chorus

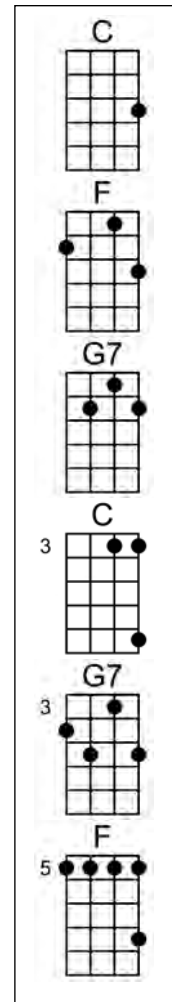

FOX ON THE RUN

TONY HAZZARD

Intro: C G D G

Strum D DU UDU or fingerpick

First note=A

Chorus

G D Am C
 She walks through the corn leading down to the river
 Am D C G
 Her hair shone like gold in the hot mornin' sun
 G D Am C
 She took all the love that a poor boy could give her
 Am D C G
 And left me to die like a fox on the run
 C G
 Like a fox, (like a fox, like a fox) on the run

C G D G
 Everybody knows the reason for the fall
 C G A7 D
 When woman tempted man down in paradise hall
 C G D G
 This woman tempted me then took me for a ride
 C G D G
 But like a lonely fox, boys I need a place to hide

Chorus. then Solo

C G D G
 We'll drink a glass of wine boys to fortify our souls
 C G A7 D
 We'll talk about the world and friends we used to know
 C G D G
 I see a string of girls who have put me on the floor
 C G D G
 The game is nearly over and the hounds are at my door

Chorus

Solo over verse:

A	-----	-----	-----	-----
E	-----3-3-----3-3-	-5-5-3-2-3-	-----3-3-----3-	-5-5-5-
C	-2-3-4-----4-2-----	-----	-2-4-----4-2---	-----
G	-----	-----	-----	-----

A	-----	-----	-----	-----
E	-----3-3-----3-	-3-5-5-3-2-3-	-----3-3-----3-	-3-5-5-3-2-3-
C	-2-4-----4-2---	-----	-2-4-----4-2---	-----
G	-----	-----	-----	-----

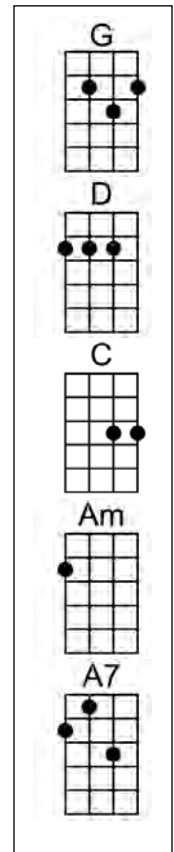

FUNNY HOW TIME SLIPS AWAY

WILLIE NELSON

Strum=D DU UD

First note=A

D G D
Well hello there my it's been a long long time

G D
How am I doin' oh I guess that I'm doin' fine

D7 G E7
It's been so long now but it seems now it was only yesterday

A7 Em A7 D
Gee ain't it funny how time slips away

D G D
How's your new love I hope that he's doing fine

G D
Heard you told him that you'd love him till the end of time

D7 G E7
Now that's the same thing that you told me seems like just the other day

A7 Em A7 D
Gee ain't it funny how time slips away

Solo

D G D
I gotta go now I guess I'll see you around

G D
Don't know when though never know when I'll be back in town

D7 G E7
But remember what I tell you that in time you're gonna pay

A7 Em A7 D
And it's surprising how time slips away

Lick .hello there...

A	-----2-
E	-2-3-2-----3-
C	-2-----2-----2-
G	-2-----2-1-0-

Solo

A	-0---0--- ----- ----- ----- -----9-
E	---2---2- -0---0--- ----- -5-7-5--- -5-7-8---
C	----- ---2---2- -2-2----- -----6- -----
G	----- ----- -----4-2- ----- -----
A	-7-7-5-7-9-7-5- -14-14-14-12--- -10-9-7-9-5- ---5-----
E	-----4- ----- ----- ----- -----
C	-----4- -----9- ----- ----- -----
G	-----4- ----- ----- -5---5-4-3-2-

GOING DOWN THIS ROAD FEELING BAD

Strum=D DU UD or fingerpick 4,1,3,2

UNKNOWN

First note= F#

Chorus

D **D7**
 I'm going down this road feeling bad,
G **D**
 I'm going down this road feeling bad,
G **D**
 I'm going down this road feeling bad, Lord Lord,
A **A7** **D**
 And I ain't gonna be treated this a- way.

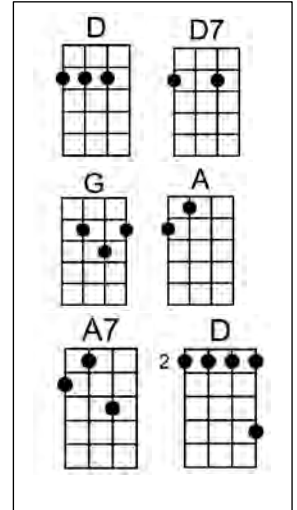

I'm down in that jail on my knees,
 I'm down in that jail on my knees,
 I'm down in that jail on my knees,
 And I ain't gonna be treated this a- way.

They feed me on cornbread and beans
 They feed me on cornbread and beans
 They feed me on cornbread and beans
 And I ain't gonna be treated this a- way.

Intro	A7	D	Solo ...
A	-----0-0---0-----0-		-----0-0-2-0-0---
E	-2-3--3---3---1-2---2-		-2-3-----2-
C	-----1-----2-2-		-----
G	-----2-----2-		-----

'Cause your two dollar shoes hurt my feet,
 'Cause your two dollar shoes hurt my feet,
 'Cause your two dollar shoes hurt my feet,
 And I ain't gonna be treated this a- way.

Solo

I'm going where the weather suits my clothes,
 I'm going where the weather suits my clothes,
 I'm going where the weather suits my clothes,
 And I ain't gonna be treated this a- way.

I'm going down this road feeling bad,
 I'm going down this road feeling bad,
 I'm going down this road feeling bad, Lord Lord,
 And I ain't gonna be treated this a- way.

Chorus

GOLD WATCH AND CHAIN

A.P. CARTER

Intro: G C G or below

Strum =dD or D DUD DUD DUD

First note=C

Chorus

G C G
Oh I'll pawn you my gold watch and chain love

D7 G
And I'll pawn you my gold wedding ring

C G
I will pawn you this heart in my bosom

D7 G
Only say that you love me again

C G
Darling how can I stay here without you

D7 G
I have nothing to cheer my poor heart

C G
This old world would seem sad love without you

D7 G
Tell me now that we never will part

Chorus

C G
Take back all the gifts you have given

D7 G
A diamond ring and a lock of your hair

C G
And a card with your picture upon it

D7 G
It's a face that is false but is fair

Chorus

C G
Oh the white rose that blooms in the garden

D7 G
It grows with the love of my heart

C G
It broke through on the day that I met you

D7 G
It will die on the day that we part

Chorus

Then tag D7 G C G
Only say that you love me again

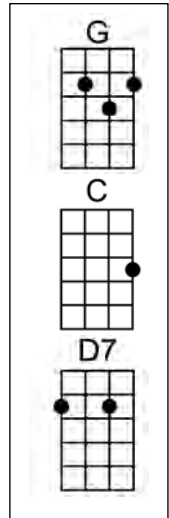

Intro	
A	-----0-----
E	-0-2-3-0-2-3---3-0---
C	-----2-----
G	-----
G	
A	-----0-2-----0----- -2-
E	-2-3-----2---2---3--- -3-
C	-----2----- -2-
G	----- -0-

GREEN GREEN GRASS OF HOME

CURLY PUTMAN

Intro: G D G

Strum=D DU UD

First note=G

G C G
The old hometown looks the same as I step down from the train

D
There to meet me is my mama and papa

G C
Down the lane I look and there runs Mary, hair of gold and lips like cherry

G D G
It's good to touch the green, green grass of home

G C G
The old house is still standing, though the paint is cracked and dried

D
There's the old oak tree that I used to play on

G C
Down the lane I walk with my sweet Mary, hair of gold and lips like cherry

G D G
It's so good to touch the green, green grass of home

Chorus

G C
Yes they'll all come to meet me arms out-stretched, smiling sweetly

G D G
It's so good to touch the green green, grass of home

G C G
Then I awake and I look around me at the four gray walls that surround me

D
And I realize that I was only dreamin'

G
For there's the guard and there's the sad old padre

C
And arm-in-arm, we'll walk at daybreak

G D G
And again I'll touch the green green grass of home

Chorus

G
Yes they'll all come to see me in the shade of that old oak tree

G D C G
When they lay me 'neath the green green, grass of home

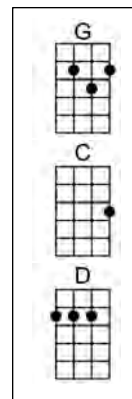

HAPPY TRAILS

DALE EVANS & ROY ROGERS

Intro Dm G7 C G7

Strum D D UU D

First note=G

CHORUS

C Gdim7 G7
 Happy trails to you until we meet again
 G G+ C
 Happy trails to you, keep smilin' until then
 C C7 F
 Who cares about the clouds when we're together
 A7 D7 G7
 Just sing a song and bring the sunny weather
 C A7 Dm G7 C G7
 Happy trails to you till we meet a - gain

C A7
 Some trails are happy ones
 Dm
 Others are blue
 G7
 It's the way you ride the trail that counts
 C G7
 Here's a happy one for you

C Gdim7 G7
 Happy trails to you until we meet again
 G G+ C
 Happy trails to you, keep smilin' until then
 C C7 F
 Who cares about the clouds when we're together
 A7 D7 G7
 Just sing a song and bring the sunny weather
 C A7 Dm G7 C G7
 Happy trails to you till we meet a - gain

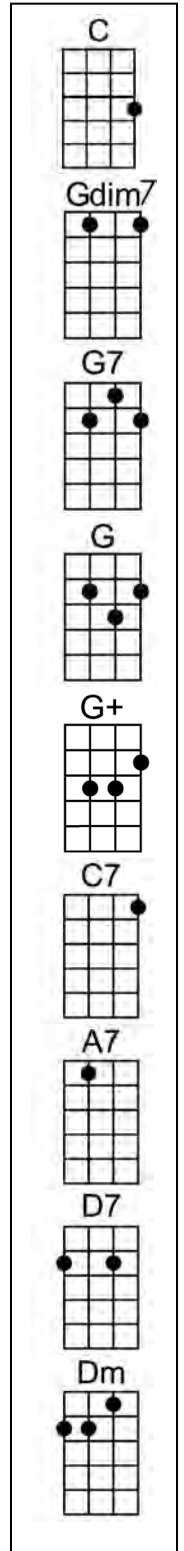

HARD TIMES

GILLIAN WELCH

Intro Am Em7 F C

Strum D D UU D

First note=E

There was a Camptown man who used to plow and sing

He loved that mule and the mule loved him

When the day got long as it does about now

I'd hear him singing to his muley cow

Calling come on my sweet old girl, I'd bet the whole damn world

We're gonna make it yet to the end of the row

CHORUS Am Em7 F C
Singing hard times ain't gonna rule my mind

Hard times ain't gonna rule my mind, Bessie

Hard times ain't gonna rule my mind, no more

He said it's a big old world, heavy in need

That big machine is just a-picking up speed

We're supping on tears and we're supping on wine

But we all get to heaven in our own sweet time

So come on you Asheville boys, Turn up your old time noise

Kick till the dust comes up from the cracks in the floor

CHORUS, then Instrumental Break Am Em7 F C

But the Camptown man he doesn't plow no more

I seen him walking down to the superette store

Guess he lost that nag and he forgot that song

Woke up one morning and the mule was gone

So come all ye ragtime kings Come on you dogs that sing

Pick up your dusty old horn and give it a blow CHORUS

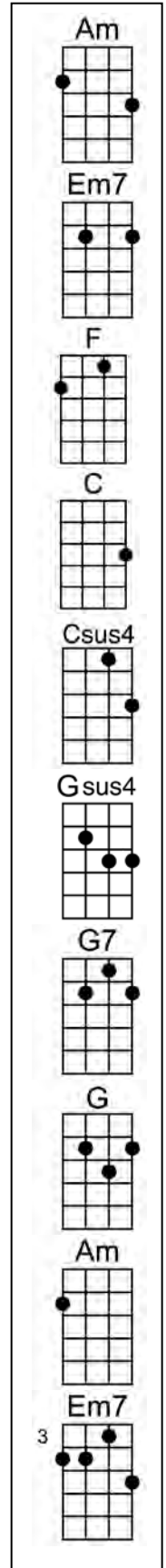

HELP ME MAKE IT THROUGH THE NIGHT

KRIS KRISTOFFERSON

Strum= DU UDU or fingerpick

First note=A

n.c. Gsus4 Gsus2 G G7
 Take the ribbon from your hair
 G7 C
 Shake it loose and let it fall
 D7
 Laying soft against your skin
 G Gsus4 G
 Like the shadows on the wall

G Gsus4 Gsus2 G G7
 Come and lay down by my side
 G7 C
 'Til the early morning light
 D7
 All I'm taking is your time
 G C G
 Help me make it through the night

Chorus
 I don't care what's right or wrong C
 I won't try to understand G
 Let the devil take tomorrow A7
 "Cuz tonight I need a friend D

G Gsus4 Gsus2 G G7
 Yesterday is dead and gone
 C
 And tomorrow is out of the sight D7
 And it's sad to be alone
 G
 Help me make it through the night

Chorus - Solo

G Gsus4 Gsus2 G G7
 Yesterday is dead and gone
 C
 And tomorrow is out of the sight D7
 And it's sad to be alone

G Gsus4 G
 Help me make it through the night
 D7 n.c.
 I don't want to be alone
 C Gsus2 G
 Help me make it through the night

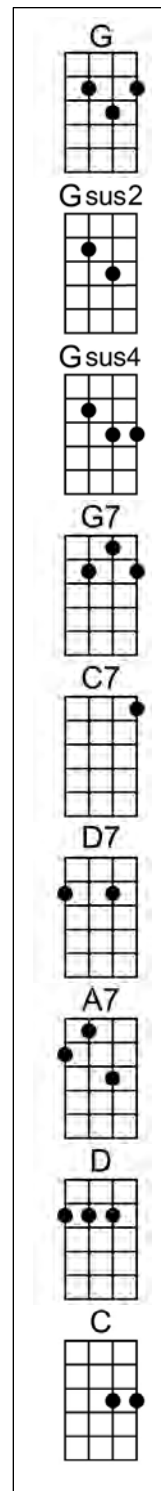

Solo melody

A	---2-3-2-0-2---	-2-2-2-2-2p0-0---
E	-3-----	-----3-
C	-----2-	-----
G	-----	-----

A	-3-3-3-2-0-3---	-3-3-2-0-2-0---
E	-----2-	-----3-
C	-----	-----
G	-----	-----

HEY GOOD LOOKIN'

HANK WILLIAMS

Intro: D7 G7 C

C
Hey hey Good lookin' whatcha got cooking?

D7 G7 C
How's about cooking somethin' up with me?

C
Hey sweet baby don't you think maybe

D7 G7 C
We could find us a brand new recipe

C7 F C
I got a hot rod Ford and a two dollar bill

F C
And I know a spot right over the hill

F C
There's soda pop and the dancin's free

D7 G7
So if you wanna have fun come along with me

C
Say hey Good lookin' whatcha got cooking?

D7 G7 C
How's about cooking somethin' up with me?

C
I'm free and ready so we can go steady

D7 G7 C
How's about saving all your time for me

C
No more lookin' I know I've been taken

D7 G7 C
How's about keepin' steady company?

C7 F C
I'm gonna throw my date book over the fence

F C
And buy me one for five or ten cents

F C
I'll keep it 'til it's covered with age

D7 G7
'Cause I'm writin' your name down on every page

C
Say hey good lookin' whatcha got cooking?

D7 G7 C F C F C
How's about cooking somethin' up with me?

First note=C

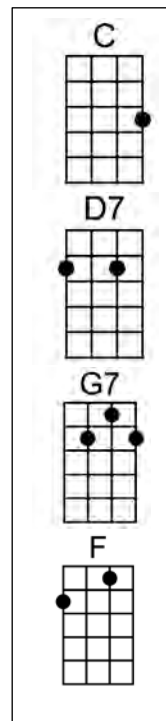

HICKORY WIND

GRAM PARSONS

Intro: G C G D7 G

Strum=D DU UDU

First note=B

G D7 C G
 In South Carolina there are many tall pines
 G D7 C D7
 I remember the oak tree that we used to climb
 D7 C D7 G
 But now when I'm lonesome, I always pretend
 G C D7 G C G
 That I'm getting the feel of hickory wind

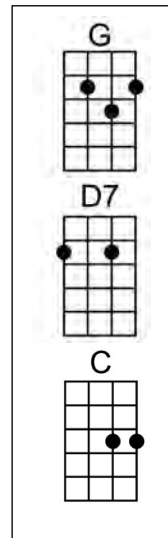

G D7 C G
 I started out younger at most everything
 G D7 C D7
 All the riches and pleasures, what else could life bring?
 D7 C D7 G
 But it makes me feel better each time it begins
 G C D7 G C G
 Callin' me home, hickory wind

G D7 C G
 It's a hard way to find out that trouble is real
 G D7 C D7
 In a far away city, with a far away feel
 D7 C D7 G
 But it makes me feel better each time it begins
 G C D7 G C G
 Callin' me home, hickory wind
 G C D7 G C G D7 G
 Keeps callin' me home, hickory wind

Melody				
A	-2-2-3-2-0-----	-----0-2-	-2-2-3-2-0-----	-----0-
E	-----3-2-	-3-0-3-----	-----3-2-	-3-3-3-----
C	-----	-----	-----	-----
G	-----	-----	-----	-----
A	---5-----	-----	-5-----	-----
E	-----8-7-----	-5-5---5-7-	---8-7---	-----5---
C	-----7-7-	-----7-----	-----7-	-6-7---7-
G	-7-----	-----	-----	-----

HONEY YOU DON'T KNOW MY MIND

JIMMY MARTIN

Intro:below or C

Strum=D DU UD

First note=E

C F
Honey you don't know my mind I'm lonesome all the time

G7 C
Now you're born to lose a drifter that's me

F
You can travel for so long till a rambler's heart goes wrong

G7 C
Baby you don't know my mind today

C F
I've been a hobo and a tramp, my soul has done been stamped

G7 C
Thank God though I've learned the hard, hard way

F
When I find I can't win I'll be checking out again

G7 C
Baby you don't know my mind today

C F
Heard the music of the rail, slept in every old dirty jail

G7 C
And life's too short for you to worry me

F
You say I'm sweet and kind I can love a thousand times

G7 C
Baby you don't know my mind today

C F
Honey you don't know my mind I was born the restless kind

G7 C
You made it rough let's keep it that way

F
You're gonna find you were wrong when your loving daddy's gone

G7 C
Baby you don't know my mind today

F
You're gonna find you were wrong when your loving daddy's gone

G7 C
Baby you don't know my mind today

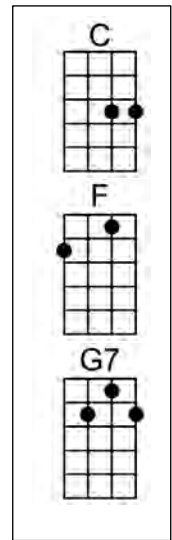

Intro	C
A	-----3-
E	0--1-2-3-3-
C	-----0-
G	--0-2-3-0-0-

I ALWAYS GET LUCKY WITH YOU

MERLE HAGGARD

FREDDY POWERS, GARY CHURCH

Intro: A A+ F#m A7 A E7 A E7 3/4 time Strum=D UD

First note = C#

A A+
I've had good luck and bad luck
F#m A7
And no luck, it's true
A E7 A E7
But I always get lucky with you

A A+
I've been turned on and turned down
F#m A7
When the bars close at two
A E7 A E7
But I always get lucky with you

Bridge
D A
I keep two strikes against me most all of the time
B7 Badd9 E7
When it's down to a phone call I'm minus the dime

A A+
There's been good days and bad days
F#m A7
But when the day is through
A E7 A D A
I'll always get lucky with you

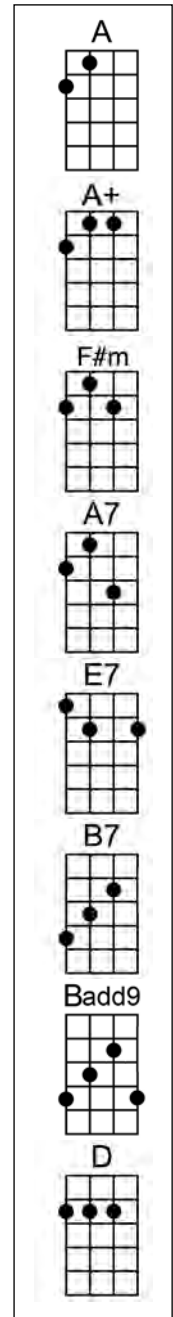

Repeat bridge and last verse then solo

Solo				
A	-----	-----0-2-3-2p-0-	-2-3-4-0-	-----2-0-
E	-----0-----0-1--	-1-2-----	-----	-2-0-4-----
C	-1-2---1---1-	-----	-----	-----
G	-----	-----	-----	-----
Bridge				
A	-0-0-0---0-2-0-	-----	-----0---	-2-4-2-0-0-----
E	-----2-----	2-2-0---0-	-2-4---2-	-----4---0-
C	-----	-----1---	-----	-----1---
G	-----	-----	-----	-----

I AM A PILGRIM

TRADITIONAL

Merle Travis

First note= G

Intro: below

Strum=D DU UD or fingerpick 4,1,3,2

C G C C7
I am a pilgrim and a stranger
F F7 C
Travelling through this wearisome land
C C7 F F7
I've got a home in that yonder city, good Lord
C riff G C
And it's not not made by hand

C G C C7
I've got a mother, sister and a brother
F F7 C
Who have been this way before
C C7 F F7
I am determined to go and see them, good Lord
C G C
Over on that other shore

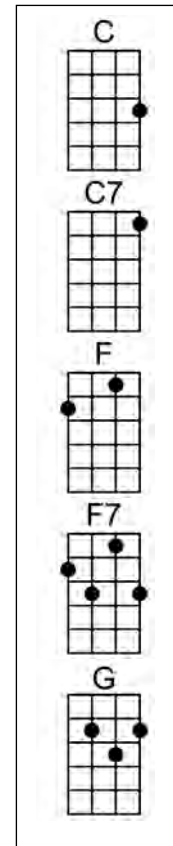

SOLO begin on open 4th string G

C G C C7
I going down to the river of Jordan
F F7 C
Just to bathe my troubled soul
C C7 F F7
If I can just touch the hem of his garment, good Lord
C G C
Then I know he'd take me home

C G C C7
I am a pilgrim and a stranger
F F7 C
Travelling through this wearisome land
C C7 F F7
I've got a home in that yonder city, good Lord
C riff G C
And it's not not made by hand

Intro and end of verse riff

```
A -----3---
E ----0-1-3-----0---
C -0-0-----2-3p2-0--2--0---
G-----2-----0---
```

Solo

```
A -----
E -----0-----
C ----0-2-2--3-2-0--0 0----2-0--0
G-0-2-----2-----2-
```

....

I AM WEARY LET ME REST

PETE KUYKENDALL

Intro: C G7 C

Strum =dD dD dD dD

First note= G

C F C
Kiss me mother kiss your darling
G7

Lay my head upon your breast

C
Throw your loving arms around me

G7 C
I am weary let me rest

G7 C
Seems my life is swiftly fading

G7
Brighter scenes, they do now show

F C
I am standing by the river

G7 C
Angels wait to take me home

C F C
Kiss me mother kiss your darling
G7

See their fate upon my brow
C

While I'll soon be with the angels
G7 C

Faith has doomed my future well

G7 C
Through the years you've always loved me
G7

And my life you tried to save
F C

But now I shall slumber sweetly
G7 C

In a deep and lonely grave

C F C
Kiss me mother kiss your darling
G7

Lay my head on your breast
C

Throw your loving arms around me
G7 C

I am weary let me rest I am weary let me rest

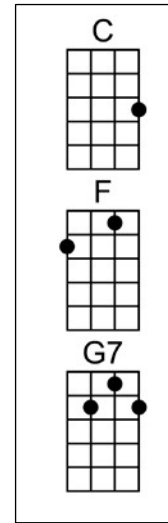

I KNOW YOU RIDER

TRADITIONAL

Intro D 4 bars

Strum= D DU UD

First note=D

D C G D
I know you rider, gonna miss me when I'm gone;
D C G D
I know you rider, gonna miss me when I'm gone;
F C F C Em D
Gonna miss your baby, from rollin' in your arms.

D C G D
Lay down last night, Lord I could not take my rest;
D C G D
Lay down last night, Lord I could not take my rest;
F C F C Em D
My mind was wanderin' like the wild geese in the west.

Solo

D C G D
The sun will shine in my back door someday;
D C G D
The sun will shine in my back door someday;
F C F C Em D
March winds will blow all my troubles away.

D C G D
I wish I was a headlight, on a North bound train;
D C G D
I wish I was a headlight, on a North bound train;
F C F C Em D
I'd shine my light through the cool Colorado rain.

Solo

D C G D
I'd rather drink muddy water, sleep in a hollow log
D C G D
I'd rather drink muddy water, sleep in a hollow log
F C F C Em D
Then stay here in 'Frisco, be treated like a dog

D C G D
I know you rider, gonna miss me when I'm gone;
D C G D
I know you rider, gonna miss me when I'm gone;
F C F C Em D
Gonna miss your baby, from rollin' in your arms.

F C F C G D
Gonna miss your baby, from rollin' in your arms.

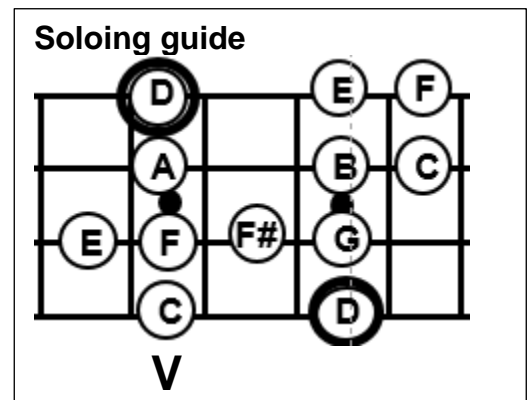
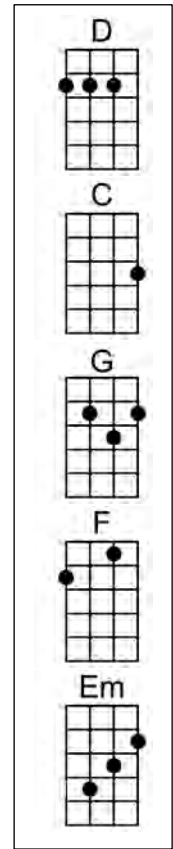

I SHALL BE RELEASED

BOB DYLAN

Intro: Em G G

Strum=D DU UD

First note = E

C Dm
They say everything can be replaced
Em Dm C
They say every distance is not near
C Dm
So I remember every face
Em C
Of every man who put me here

Chorus:

C Dm
I see my light come shinin'
Em Dm C
From the West down to the East
C Dm
Any day now, any day now
Em C
I shall be released

C Dm
They say every man needs protection
Em Dm C
They say that every man must fall
C Dm
Yet I swear I see my reflection
Em C
Somewhere so high above this wall

Chorus

Instrumental Verse Solo x2

C Dm
Now yonder stands a man in his lonely room
Em C
A man who swears he's not to blame
C Dm
All day long I hear him shouting so loud
Em C
Cryin' out that he was framed

Chorus x 2

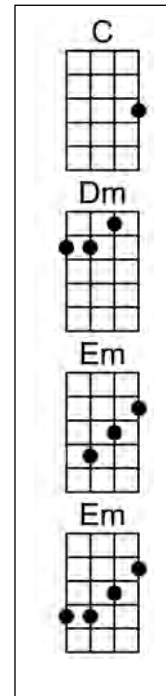

Additional verse:

C Dm
He will find you where your stayin'
Em Dm C
Evn' in the arms of somebody else's wife
C Dm
Your laughin' now, you should be prayin'
Em C
In the midnight hour of your life

C Dm
I see my light come shinin'
Em Dm C
Don't need no doctor or no priest
C Dm
Any day now, any day now
Em C
I shall be released

I'LL BE YOUR BABY TONIGHT

BOB DYLAN

Intro: F

Strum=D DU UD

First note = A

F
Close your eyes, close the door,
G
You don't have to worry any more.
Bb C F
I'll be your baby tonight.

F
Shut the light, shut the shade,
G
You don't have to be afraid.
Bb C F
I'll be your baby tonight.

Bb
Well, that mockingbird's gonna sail away,
F
We're gonna forget it.
G
That big, fat moon is gonna shine like a spoon,
C
But we're gonna let it,
[n.c.]
You won't regret it.

F
Kick your shoes off, do not fear,
G
Bring that bottle over here.
Bb C F
I'll be your baby tonight. (Repeat all or part of the song.)

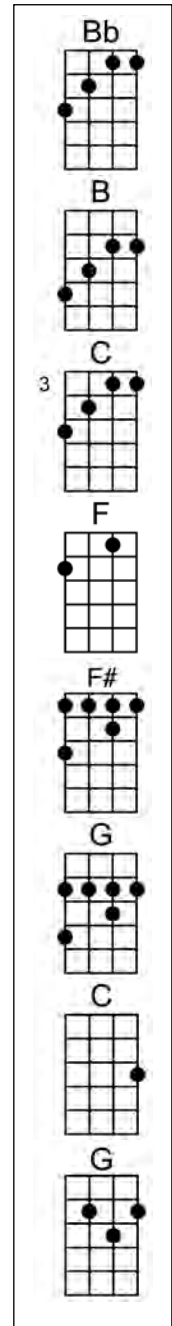

I'LL FLY AWAY

ALBERT E. BRUMLEY

Intro: C C G C

Strum=dD dD dD dD or D DU UD

First note=E

C F C
Some glad morning when this life is over, I'll fly away
C G C
To a home on God's celestial shore, I'll fly away
C F C
I'll fly away, O Glory, I'll fly away;
C G C
When I die, hallelujah, by and by, I'll fly away.

C F C
When the shadows of this life are gone, I'll fly away;
C G C
Like a bird from prison bars have flown, I'll fly away
C F C
I'll fly away, O Glory, I'll fly away;
C G C
When I die, hallelujah, by and by, I'll fly away.

C F C
Just a few more weary days and then, I'll fly away;
C G C
To a land where joys shall never end, I'll fly away.
C F C
I'll fly away, O Glory, I'll fly away;
C G C
When I die, hallelujah, by and by, I'll fly away.

C G C or a capella
When I die, hallelujah, by and by, I'll fly away.

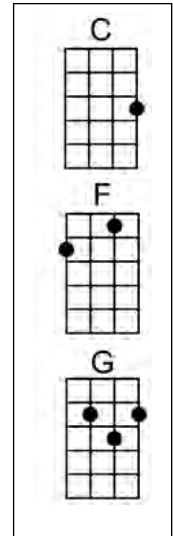

I'M MOVIN ON

HANK SNOW

Intro D Dsus2 D Dsus2 or harp Strum D DU UD First note=G
D

That big eight wheeler, rolling down the track means your true loving daddy ain't coming back

I'm moving on, I'll soon be gone

You were flying too high for my little old sky so I'm moving on

That big loud whistle as it blew and blew said hello to the southland, we're coming to you

and we're moving on, oh hear my song

You had the laugh on me, so I set you free and I'm moving on.

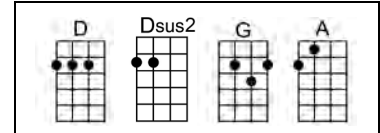

Mister fireman won't you please listen to me 'cause I got a pretty mama in Tennessee

Keep moving me on, keep rolling on

So shovel the coal, let this rattler roll and keep moving me on.

Mister engineer take that throttle in hand this rattler's the fastest in the southern land

to keep moving me on, keep rolling on

You gonna ease my mind, put me there on time and keep rolling on.

I've told you baby from time to time but you just wouldn't listen or pay me no mind

now I'm moving on, I'm rolling on

You've broken your vow and it's all over now so I'm moving on.

You've switched your engine now I aint got time for a triflin' woman on my main line

I'm moving on, you done your daddy wrong

I warned you twice now you can settle the price cause I'm moving on.

But someday baby when you had your play you're gonna want your daddy but your daddy'll say

Keep moving on, you stayed away too long

I'm through with you too bad you're blue keep moving on.

I'M NOT AFRAID TO DIE

Intro D A Asus4 E7 A

A
Nobody knows what waits ahead
D A E7

Beyond the earth and sky
D A Asus4
Lai, lai, lai
E7 A
I'm not afraid to die

A
And let the work of my own hand
D A E7
Be broken by and by
D A Asus4
Lai, lai, lai
E7 A
I'm not afraid to die

A
Sometimes it finds me fast asleep
D A E7
And wakes me where I lie
D A Asus4
Lai, lai, lai
E7 A
I'm not afraid to die

A D A E7 D A Asus4 E7 A

A
Forget my sins upon the wind
D A E7
My hobo soul will ride
D A Asus4
Lai, lai, lai
E7 A
I'm not afraid to die

D A Asus4
Lai, lai, lai
E7 A
I'm not afraid to die

Strum D DU $\frac{3}{4}$ time

TRADITIONAL

First note=D

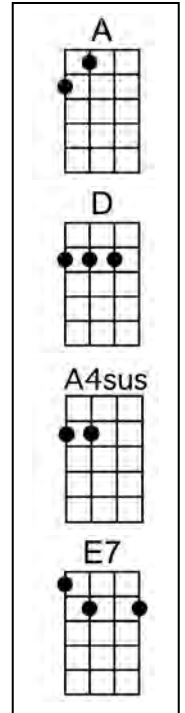

Solo

A	----- -----
E	-----0----- -----0-2-----
C	-1-1-----1---2-1- -2-2-----1-
G	-----2-2----- -----2-

A	-0----- ----- ---
E	----- ----- ---
C	-----2-1- -1-2-1- -2-
G	----- -2-4-----4-2- -1-

I'M THINKING TONIGHT OF MY BLUE EYES

CARTER FAMILY

Intro: C G7 C

Strum=D DUDUD

First note = B

Would've been better for us had we never
In this wide wicked world had never met
For the pain and the pleasure we've known together
I'm sure, love, I'll never forget

Chorus

Oh, I'm thinking tonight of my blue eyes
Who is sailing far over the sea
Oh, I'm thinking tonight of my blue eyes
And I wonder if she ever thinks of me

Oh, you told me once, dear, that you loved me
And you swore that we never would part
But a link in the chain has been broken
Leavin' me with a sad and aching heart

Chorus

When the cold, cold grave shall enclose me
Will you come there and shed just one tear
And say to the strangers around you
A poor heart you have broken lies here

Repeat Chorus

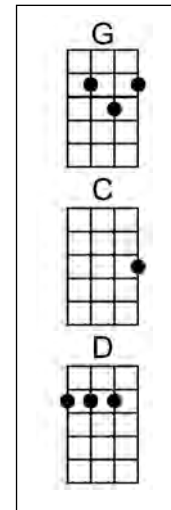

IF I LOSE, I DON'T CARE

CHARLIE POOLE

Intro: D

Strum= dD or D DU UD

First note=A

D
I can't walk, and neither can I talk

G D
Just getting back from the state of old New York

A D
One morning, jus 'fore day

Flossie, oh, Flossie, now what is the matter?
Walked all the way from old Cincinnata
One morning, before day

Chorus

D A7 D
If I lose let me lose. I don't care how much I lose

D G
If I lose a hundred dollars while I'm trying to win a dime

A7 D
For my baby she keeps money all the time.

Solo

The blood was a-running and I was running too
To give my feet some exercise. I had nothing else to do
One morning, jus 'fore day

Chorus

The peas was so greasy, the meat was so fat
The boys was fighting Spaniards while I was fighting gnats
One morning, just 'fore day

Chorus

You ought to see them boats commin' round the bend
Every one was loaded down with American men
One morning, just 'fore day

Chorus, Solo

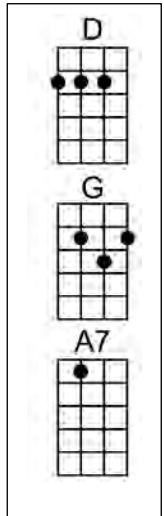

Solo					
A	-----	-----	-5-5-5-5-7-5-	-7-8-----	-----
E	-5-5-5-5-7-5-	-7-5-----	-----	-----6h7---	---5-5-----
C	-----	-----5h6---	-----	-----7-	-6-----5h6---
G	-----	-----7-	-----	-----	-----7-

IF WE MAKE IT THROUGH DECEMBER

MERLE HAGGARD

Strum= D DU UDU or fingerpick

First note=E

Chorus

C F
 If we make It through December
 Fm C CM7 Am
 Every thing's gonna be alright I know
 Dm
 It's the coldest time of winter
 G7 C Bb F C
 and I shiver when I see the falling snow
 C7 F
 If we make It through December
 Fm C CM7 Am
 Got plans to be a warmer town come summer time
 Dm
 Maybe even California
 G7 Dm G7 C Bb F C
 If we make It through December we'll be fine

C Dm
 Got laid off down at the factory
 G7 Dm G7 C
 And their timing's not the greatest in the world
 Dm
 Heaven knows I been working hard
 G7 Dm G7 C
 Wanted Christmas to be right for daddy's girl
 C7 F
 I don't mean to hate December
 Fm C CM7 Am
 It's meant to be the happy time of year
 Dm
 And my little girl don't understand
 G7 C Bb F C
 why daddy can't afford no Christmas here

Solo

Repeat Chorus

Solo				
A	----	3-3-3-2-2-0-	0-0-0-----	----- ----- ...
E	0-3-----	-----	3-----0-	0-1-3-3-1-0----
C	-----	-----	0-2----	-----2----
G	-----	-----	-----	-----2- -----

IN THE PINES

LEADBELLY

Intro: Harp or Whooee-whoohoo-whoohoo

Strum=d D D First note = C#

Chorus

A D C
In the pines, in the pines, where the sun never shines
A E7 A
and I shiver where the cold winds blow

A D C
Now girl, little girl, don't you lie to me
A E7 A
tell me where did you sleep last night
Chorus

A D C
Little girl, little girl, where you been so long?
A E7 A
Not even your mama knows.
Chorus

A D C
My girl, my girl, where will you go
A E7 A
I'm going where the cold wind blows
Chorus

Chorus

A D C A E7 A
The longest train I ever seen was on the Georgia line
A D C A E7 A
The engine passed at six o'clock, and the cab came past at nine
A D C A E7 A
My daddy, he was a railroad man, killed a mile and a half from town.
A D C A E7 A
His head, was found neath' the driving wheel, his body was never found

Chorus

A A7 D C
Whooee-whoohoo; whoohoo-whoohoo
A E7 A
Whooee-whoohoo- whoohoo- whoohoo!

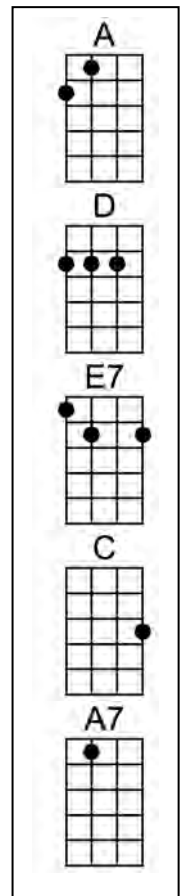

LAST TRAIN FROM POOR VALLEY

NORMAN BLAKE

Strum=D DU UDU or fingerpick

First note =A

D A G D
Well it was good one time everything was mighty fine

D A D A
The coal tipples roared day and night

D A G D
But things they got slow for no reason that I know

D A D
And ill winds they hove into sight

The mines all closed down everybody laid around
There wasn't very much left to do
Except stand in that line to get your ration script on time
And woman I could see it killin' you

Chorus

D A D
Now the soft new snows of December

G D
Lightly fall my cabin 'round

D G
And the last train from Poor Valley

D A D
Takin' brown haired Becky Richmond bound

It's been a comin' on and on lord soon you would be gone
For leavin' crossed your mind every day
Then you said to me things are bad back home you see
I guess I better be on my way

Chorus

Well I should blame you know but I never could somehow
A miner's wife you weren't cutout to be
It wasn't what you thought just some dreams that you'd bought
When you left home and ran away with mel

Chorus

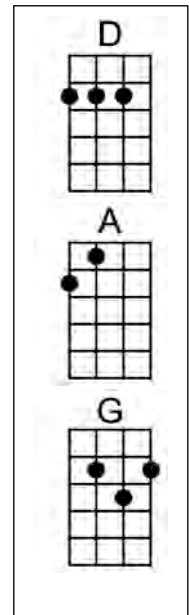

LIFE'S RAILWAY TO HEAVEN

CHARLES DAVIS TILLMAN

Intro: D G D A D

Strum=D DU UDU First note=D

D
 Life is like a mountain railroad
 G D
 With an engineer that's brave

We must make the run successful
 E7 A A7
 From the cradle to the grave

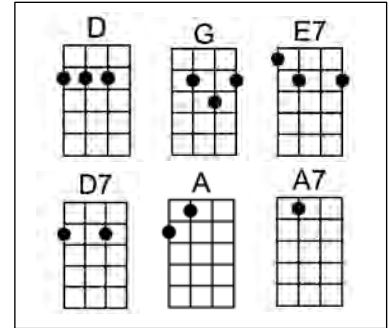

 D D7
 Watch the curves the hills and tunnels
 G D
 Never falter never fail

Keep your hand upon the throttle
 A7 D D7
 And your eyes upon the rail

Solo

A	---7-9---7-9-7---	-9-7---7-----
E	10-----10-----10-	-----10---10-7---
C	-----	-----9-
G	-----	-----
A	-----9-9-	---7-9---9-7---
E	---7-10---7-10---	-10---10---10-
C	---9---9-	-----
G	-----	-----

D7 G D
 Blessed Savior Thou will guide us
 A7
 Till we reach that blissful shore
 D G
 Where the angels wait to join us
 D A7 D
 In Thy praise for ever-more

 D
 There you'll meet the Superintendent
 G D
 God the Father God the Son

With the hearty joyous plaudit
 A7 D D7
 Weary pilgrim welcome home

D
 As you roll across the trestle
 G D
 Spanning Jordan's swelling tide

You behold the Union Depot
 E7 A A7
 Into which your train will glide

D7 G D
 Blessed Savior Thou will guide us
 A7
 Till we reach that blissful shore
 D G
 Where the angels wait to join us
 D A7 D D G DGD
 In Thy praise for ever-more

LITTLE CABIN HOME ON THE HILL

LESTER FLATT
& BILL MONROE

Intro: G D G

Strum =dD dD dD dD

First note=A

G C G
Tonight I'm alone without you my dear
Em A7 D7

Its seems there's a longing for you still

G C G
All I have to do is sit alone and cry
Em D7 G

In our little cabin home on the hill

Chorus

C D7 G
Oh someone has taken you from me
Em A7 D7

And left me here all alone

G C G
Just listen to the rain beyond my window pane
Em D7 G

In our little cabin home on the hill

C G
I hope you are happy tonight as you are
Em A7 D7

For in my heart there's a longing for you still

G C G
I'll just keep it there so I won't be alone
Em D7 G

In our little cabin home on the hill

Chorus

C G
And when you have come to the end of your way
Em A7 D7

And find there's no more happiness for you

G C G
Just let your thoughts turn back once more if you will
Em D7 G

To our little cabin home on the hill

Chorus

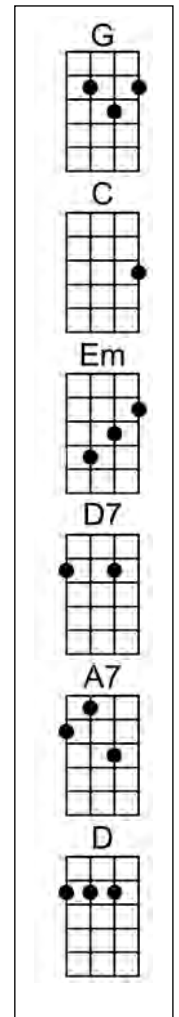

LITTLE GEORGIA ROSE

Intro: G C G

Strum=D DU UD

G
Now come and listen to my story
D7
A story that I know is true
G C G
About a rose that bloomed in Georgia
G D7 G
With hair of gold and a heart so true

Chorus

C G
Way down in the Blue Ridge mountains
C D7
Way down where the tall pines grow
G C
Lives my sweetheart of the mountains
G D7 G
She's my little Georgia rose

G
Her mother left her with another
D7
A carefree life she had planned
G C
The baby now she is a lady
G D7 G
The one her mother couldn't stand

Chorus

G
We often sing love songs together
D7
I watched her do her little part
G C G
She'd smile at me and I would tell her
G D7 G
That she was my own sweetheart

Chorus

BILL MONROE

First note=G

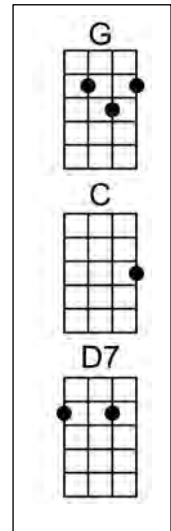

LITTLE MAGGIE

DOCK BOGGS

Intro: D C D

Strum =dD dD dD dD

First note = D

Chorus

D C D A D
 Oh, yonder stands little Maggie, with a dram glass in her hand
 D C D A D
 She's a drinkin' away her troubles, oh, lord and courtin' another man

D C D A D
 How could I ever stand it, just to see them two blue eyes?
 D C D A D
 They shine just like the diamonds, like a diamond in the sky

D C D A D
 Pretty flowers were made for blooming, pretty stars were made to shine
 D C D A D
 Pretty girls were made for lovin', surely Maggie was made for mine

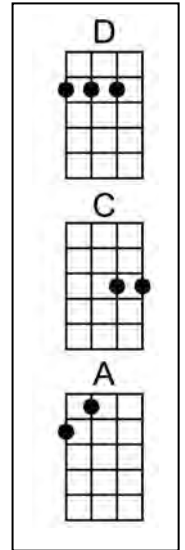

Solo

Solo			
A	-----0----- -----0-3-0----- ----- -----		
E	----- -----1-3-----3-1-- -----5----- -----5-8-5-----		
C	--2-2--2-2-2-0-- -----2- -----5-7-----7-5--		
G	----- ----- -----5-7-7--7-7-5- -----7-		

D C D A D
 Well, march me down to the station, with my suitcase in my hand
 D C D A D
 I'm goin' away for to leave you, goin' to a far distant land

D C D A D
 Oh, well, sometimes I have a nickel and sometimes I have a dime
 D C D A D
 And sometimes I have ten dollars, oh, lord, just to buy little Maggie's wine

Solo			
A	-----12----- 8-10-12-12-12-10-8-- -----12----- -----		
E	--8-9-10--10-10-8- -----10- -----10-10--10-10-8- 8-7-6-5-8-5-----		
C	----- ----- ----- -----7-5--		
G	----- ----- ----- -----7-		

D C D A D
 Go away, go away little Maggie, go and do the best you can
 D C D A D
 I'll get me another woman, you can get you another man

LITTLE SADIE

TRADITIONAL

Intro: Gm F Dm

Strum=D DU UDU or dD

First note = G

Gm
 Went out last night to take a little round
 F Dm
 I met a little Sadie and I blew her down
 Gm F Gm
 Went right home and got in bed, a .44 smokeless under my head

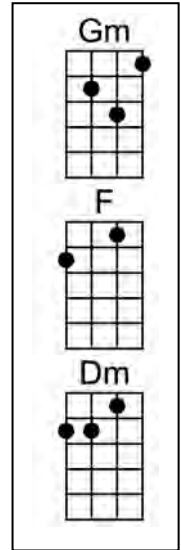

Gm
 I began to think what the deed I'd done
 F Dm
 I grabbed my hat and away I run
 Gm F Gm
 I made a good run but I run too slow, they overtook me in Jericho

Gm F Dm
 Standin' on the corner, ringin' the bell, up walks the sheriff from Thomasville

Gm
 He said "young man is your name Brown?
 F Gm
 'Remember that night you shot Sadie down?"

Solo	
A	-----5----- -----
E	-----5-6-5-6-8---6--- -----
C	-7-6-7-----7- -5-5-5---5-5-5-
G	----- -----7-----

Gm F Dm
 Oh yes sheriff my name is Lee, I murdered little Sadie in the first degree
 Gm F Gm
 First degree, second degree, if you got any papers you can read 'em for me

Gm
 Took me downtown, dressed me in black
 F Dm
 Put me on a train and they sent me back

Solo	
A	-----5-5-5----- -----
E	-----6-----6----- -----
C	-7-7-----7-5-5-5-5-5-5-
G	-----7-7-7-----

Gm F Gm
 Had no one for to go my bail, crammed me back in the county jail

Gm F Dm
 Judge and the jury took their stand, the judge had the papers in his right hand
 Gm F Gm
 41 days, 41 nights, 41 years to wear the ball and the stripes

Repeat 1st verse

LONESTAR

LEE ALEXANDER

Intro: Walkup G A B C

Strum=D DU UDU

Norah Jones
First note= C

C F C
Lonestar, where are you out tonight?
G Em7 Am Am7 Am6
This feeling I'm trying to fight...
G Em7 Am Am7 Am6
It's dark and I think that I would give anything
F G C (walk up G A B C)
For you to shine down on me....

C F C
How far you are I just don't know
G Em7 Am Am7 Am6
The distance I'm willing to go
G Em7 Am Am7 Am6
I pick up a stone that I cast to the sky
F G C (walk up G A B C)
Hoping for some kind on sign...

Solo – below

C F C
Lonestar, where are you out tonight?
G Em7 Am Am7 Am6
This feeling I'm trying to fight...
G Em7 Am Am7 Am6
It's dark and I think that I would give anything
F G C F C CM7
For you to shine down on me....

Solo - melody			
A	-----0-	-----	-----
E	---0-1---	---3-0---	-----0-3-
C	---0-----	-----2-0-	---0-2-2-2-
G	-----	-----	-----
A	-----	---0---0-	-----
E	-----	---3---3-	-----0-0-
C	---0-2-2-2-	---4-4-	---4\2-0-
G	-----	-----	---0-2-2-0-

LONG BLACK VEIL

TRADITIONAL

Intro: D D7 C G

Strum=D D UD D UD

First note=G

G
Ten years ago, on a cold dark night
D D7 C G
There was someone shot 'neath the town hall light
G
There were few at the scene, but they all agreed
D D7 C G
That the slayer who ran looked a lot like me

G
The judge said "Son, what is your alibi?
D D7 C G
If you were somewhere else you won't have to die"
G
I spoke not a word, though it meant my life
D D7 C G
For I'd been in the arms of my best friend's wife

CHORUS

C G C G
She walks these hills in a long black veil
C G C G
She visits my grave while the night winds wail
G C G
Nobody knows, nobody sees,
C D7 G
Nobody knows but me

G
The scaffold was high, and eternity near
D D7 C G
She stood in the crowd, but she shed not a tear
G
But sometimes late at night, when the cold wind moans
D D7 C G
She visits my grave, and she cries o'er my bones

CHORUS then solo begin on G

G C G C D7 G
Nobody knows, nobody sees, nobody knows but me

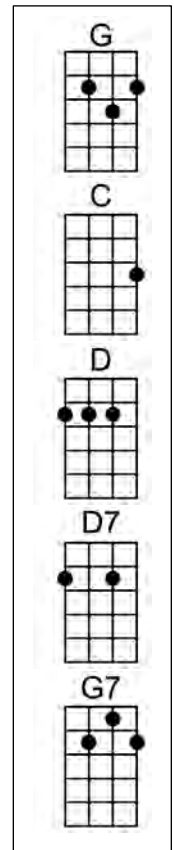

LOOK AT MISS OHIO

GILLIAN WELCH

Intro

F C G Am F C G

Strum D D UU DU

First note=A

CHORUS

F C G Am
 Oh me oh my oh, look at Miss Ohio
 F C G
 She's a-running around with her rag-top down
 G F C G
 She says I wanna do right but not right now

Am F Am G Am G
 Gonna drive to Atlanta and live out this fantasy
 F C G
 Running around with the rag-top down
 F C G
 Yeah I wanna do right but not right now

Am F Am G Am G
 Had your arm around her shoulder, a regimental soldier
 F C G
 An' mamma starts pushing that wedding gown
 F C G
 Yeah you wanna do right but not right now

CHORUS

Instrumental break – solo
 Am Am7 Am G6
 F C G Am [Chorus]
 F C G F C G

Harp Chorus - A harp

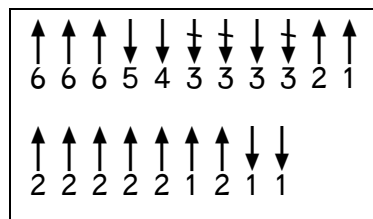

F C G Am G
 I know all about it, so you don't have to shout it
 F C G
 I'm gonna straighten it out somehow
 F C G
 Yeah I wanna do right but not right now

CHORUS

Solo

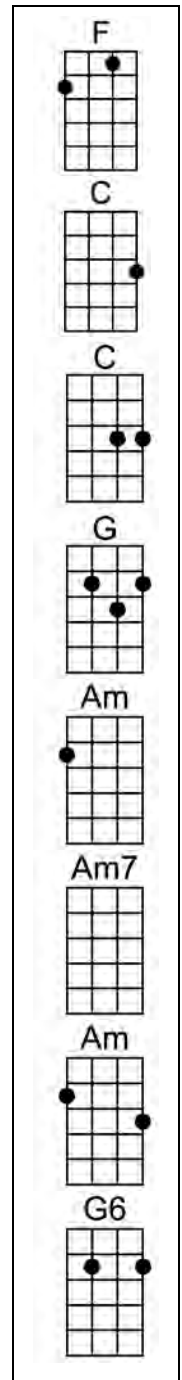
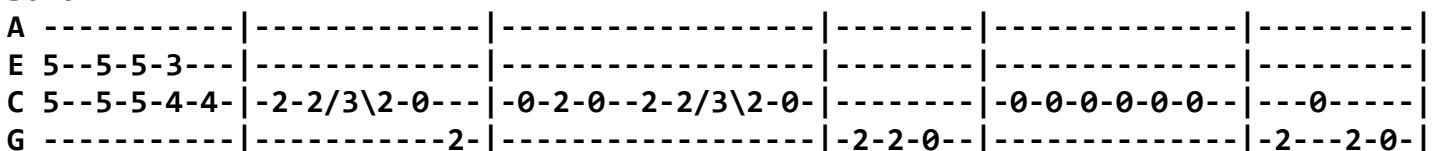

LOUISE

PAUL SEIBEL

Key of F

Bb harp

First note=G

Intro: Bb C F

Strum=D DU UD
First note=Ab

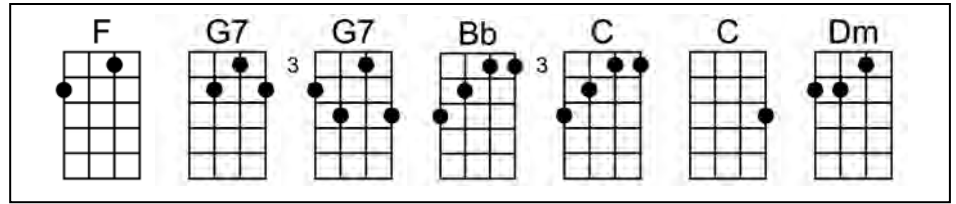

F **G7** **Bb** **C** **F**
They all said Louise was not half bad. It was written on the walls and window shades
F **G7** **B** **C** **F**
And how she'd act the little girl. The deceiver, don't believe her, that's her trade.

Bb **C** **F** **Bb** **C** **F**
Sometimes a bottle of perfume, Flowers, and maybe some lace.
Bb **C** **Dm** **G7** **C**
Men brought Louise ten-cent trinkets. Their intentions were easily traced.

F **G7** **Bb** **C** **F**
And everybody knew at times she cried But women like Louise well they get by

Solo over melody

A	-----3-5-3-----	-5-3-5-5-5-3-3-1-0-	-----3-5-3-----	-3-5-5-5-3-3-----
E	-4/5-5-----5-3--5-3-	-----	-3-5-----5-3--3-	-----5-3--
C	-----5-----	-----	-----5-----	-----5-----
G	-----	-----	-----	-----

F **G7** **Bb** **C** **F**
Ahhh, everybody thought it kinda sad When they found Louise in her room.
F **G7** **Bb** **C** **F**
They'd all put her down below their kind, Still some cried when she died this afternoon.

Bb **C** **F** **Bb** **C** **F**
Louise rode home on the mail train, Somewhere to the South, I heard them say.
Bb **C** **Dm** **G7** **C**
Too bad it ended so ugly. Too bad she had to go that way.

F **G7** **Bb** **C** **F**
But the wind is blowing cold tonight. Goodnight, Louise, goodnight.

LOVESICK BLUES

IRVING MILLS & CLIFF FRIEND

Hank Williams

Intro: G C G or below

Strum=D DU UD

First note=E

C
I got a feelin' called the blu-ues oh Lawd

G7
Since my baby said good-bye

And I don't know what I'll do-oo-oo

C
All I do is sit and sigh-gh oh Lawd

C7 F Cdim7 C A7
That last long day she said good-bye, well lawd I thought I would cry

D7
She'll do me she'll do you she's got that kind of lovin'

G7
Lawd I love to hear her when she calls me

C G7
Sweet dad-ad-ad-dy such a beautiful dream

E7
I hate to think it all o-o-ver, I've lost my heart it seems

F
I've grown so used to you some-how

C A7
Well I'm nobody's sugar-daddy now

D7 G7
And I'm lo-on-lonesome, I got the Lovesick Blu-ues

E7 Am
Well I'm in love, I'm in love with a beautiful gal

E7 Am
That's what's the matter with me

E7 Am
Well I'm in love I'm in love with a beautiful gal

D7 G7
But she don't care about me

G7
Lawd, I tried and I tried to keep her satisfied,

C
But she just wouldn't stay

D7
So now that she is lea-eav-in'

G7
This is all I can say [Repeat first 3 verses]

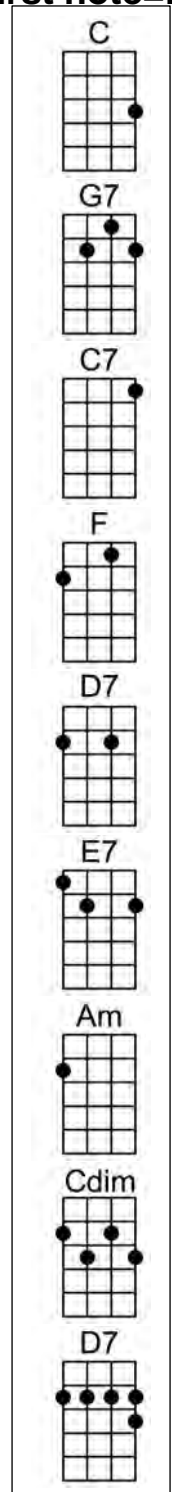

Intro			
A	-----7-	-----5----	3- -3-
E	-----	-----	----- -3-
C	-4-5-7---	-/4/-5-3-/4--	-4-
G	-----	-----	----- -5-

MAKE ME A PALLET ON YOUR FLOOR

GILLIAN WELCH

Mississippi John Hurt
First note=A

Intro C E7 F Cdim7 C G7 C C7 Strum D DU UDU
F C C7 or fingerpick 4, 3, 2, 4, 1, 3, 2

Make me a pallet on your floor

F C

Make me a pallet on your floor

C E7 F Cdim7

Make me down a pallet soft and low

C G7 C

When I'm broke and got no where to go

F C C7

Been hangin' around with a good time friends of mine

F C

Hangin' around with a good time friends of mine

C E7 F Cdim7

Oh, they treat me very nice and kind

C G7 C

When I've got a dollar and a dime

F C C7

Weary blues everywhere I see

F C

Weary in blues everywhere I see

C E7 F Cdim7

Weary blues, everywhere I see

C G7 C

No one ever had the blues like me

F C C7

Way I'm sleepin', my back and shoulders tired

F C

Way I'm sleepin', my back and shoulders tired

C E7 F Cdim7

Come tomorrow, I'll be satisfied

C G7 C

If I can catch that fast train and ride

F C C7

Make me a pallet on your floor

F C

Make me a pallet on your floor

C E7 F Cdim7

Make me down a pallet soft and low

C G7 C

When I'm broke and got no where to go

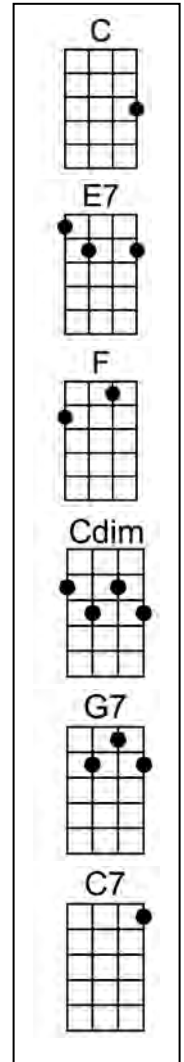

MAKE THE WORLD GO AWAY

HANK COCHRAN

Intro: C F C

Strum= DU UDU or fingerpick

First note=D

C G7
Do you remember when you loved me
C
Before the world took me astray
F
If you do then forgive me
G7 C F C
And make the world go away.

Picking pattern C	
A	-----3-----
E	-----3-----3--
C	---0-----0---
G	---0-----0---

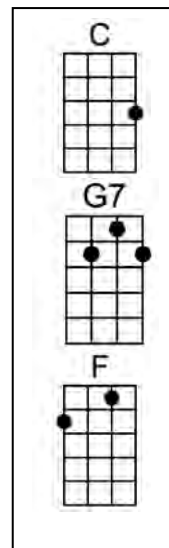

Chorus
C F G7
Make the world go away
C
And get it off my shoulders
F G7
Say the things you used to say
C F C
And make the world go away

Chorus

G7
I'm sorry if I hurt you
C
I'll make it up - day by day
F
Just say you love me like you used to
G7 C F C
And make the world go away.

Chorus

F G7
Say the things you used to say
C F C
And make the world go away

MAKING BELIEVE

JIMMY WORK

Kitty Wells

First note = E

Intro: G C or below Strum=dD dD dD dD

C F C
 Making believe that you still love me
 G C G
 It's leaving me alone and oh, so blue
 C F C
 Still I'll always dream but I'll never own you
 G C
 Making believe, it's all I can do

C G C
 Can't hold you close when you're not with me
 G C G
 You're somebody's love, you'll never be mine
 C F C
 Making believe I'll spend my lifetime
 G C
 Loving you and making believe

SOLO in C then modulate to D

Solo				C	C#	D
A	-7-5-3-5-	-10-8-10-12-10---	-7-----	-7-8-7-5-3-	-4-5-	
E	-----	-----8-	---10-8-10-	-----3-	-4-5-	
C	-7-5-4-5-	-----	-----	-----4-	-5-6-	
G	-----	-----	-----	-----5-	-6-7-	

D G D
 Making believe that I never lost you
 A D
 But my happy hours, I find are so few
 D G D
 My plans for the future will never come true
 A D
 Making believe, what else can I do
 D G D
 Making believe, I'll spend my lifetime
 A D G D G D
 Loving you and making believe

Intro	
A	-7-5-3-5- -7-8-7-5-3-
E	----- -----
C	-7-5-4-5- -7-9-7-5-4-
G	----- -----

Five guitar chord diagrams are shown vertically, each with a label above it: C, F, G, D, and A. Each diagram is a 6x4 grid representing the fretboard. The C chord has one dot on the 1st string, 1st fret. The F chord has two dots: one on the 1st string, 1st fret, and one on the 2nd string, 1st fret. The G chord has three dots: one on the 3rd string, 2nd fret, one on the 2nd string, 3rd fret, and one on the 1st string, 3rd fret. The D chord has three dots: one on the 4th string, 2nd fret, one on the 3rd string, 2nd fret, and one on the 2nd string, 2nd fret. The A chord has two dots: one on the 5th string, 2nd fret, and one on the 1st string, 2nd fret.

MAN OF CONSTANT SORROW

DICK BURNETTE

Intro: D G A D

Strum= D DU UDU

First note=F#

D G A D
 I am a man of constant sorrow, I've seen trouble all my days
 G A D A D
 I bid farewell to old Kentucky - The state where I was born and raised.

D G A D
 For six long years I've been in trouble, no pleasures here on earth I found
 G A D
 For in this world I'm bound to ramble, I have no friends to help me now.

Solo
 D G A D G A D

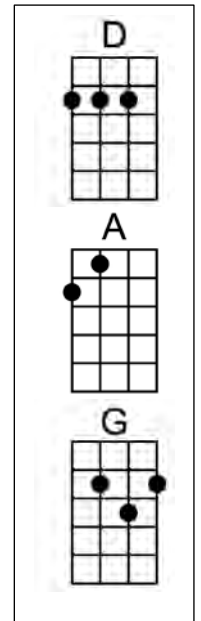

D G A D
 Fare thee well my old lover, I never expect to see you again
 G A D A D
 For I'm bound to ride that northern railroad, perhaps I'll die upon this train.

D G A D
 You may bury me in some deep valley, for many years where I may lay
 G A D A D
 Then you may learn to love another, while I am sleeping in the ground.

D G A D
 Maybe your friends think I'm just a stranger, my face you'll never see no more.
 G A D
 But there is one promise that is given, I'll meet you on God's golden shore.

Outro

A	-----5-
E	-----5-7-5-
C	5-6-----
G	-----

Solo

A	-----	-----	-----5-----	-----	5-----
E	5-----	-----	7---5-----	5---5-----	-----8-5-----
C	5-6---	-----7-	7---7---5-6---	-----7-5-6---	5---5-7-
G	-----7-	7-7-7-7-	-----7-	-----7-	7---7-----

MIDNIGHT SPECIAL

Intro: walkdown in A or harp intro

A D A
 Yonder comes Miss Rosie, how in the world do you know
 E7 A
 You can tell her by her apron and the dress that she wore
 A D A
 Umbrella on her shoulder, a piece of paper in her hand
 E7 A
 I heard her tell the captain, turn a'loose my man

Chorus

A D A
 Let the midnight special shine it's light on me
 E7 A
 Oh let the midnight special shine it's everlasting light on me

A D A
 When you get up in the morning when that big bell rings
 E7 A
 You go marching to the table, you see the same old thing
 A D A
 Knife & fork are on the table, ain't nothin in my pan
 E7 A
 if you say a word about it, you get in trouble with the man

Harp break

A D A
 If you ever go to Houston, boy you'd better walk right
 E7 A
 And you better not gamble and you better not fight
 A D A
 'Cuz Benson Crocker will arrest you and Jimmy Boone will take you down
 E7 A
 and you bet your bottom dollar that your Sugarland bound

A D A
 Let the midnight special shine it's light on me
 E7 A D A
 Oh let the midnight special shine it's everlasting light on me

LEADBELLY

First note = C#

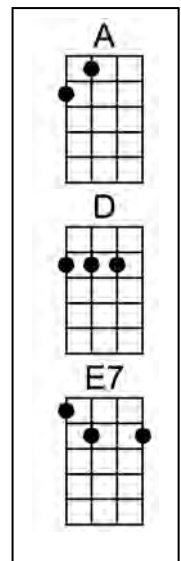

MR BOJANGLES

JERRY JEFF WALKER

Intro: F Am Dm F x2

Strum= D DU UDU

First note=G

F Am Dm F Bb C
 I knew a man Bojangles and he danced for you, in worn out shoes
 F Am Dm F Bb C
 Silver hair and ragged shirt and baggy pants, He did the old soft shoe
 Bb Am A7 Dm F+ F G7 C
 He jumped so high, jumped so high, then he'd lightly touch down

F Am Dm F Bb C
 I met him in a cell in New Orleans, I was down and out
 F Am Dm F Bb C
 He looked to me to be the eyes of age, as he spoke right out
 Bb Am Dm F+ F G7 Gm7 C
 He talked of life he talked of life, he laughed slapped his leg a step

F Am Dm F Bb C
 He said the name Bojangles and he danced a lick, across the cell
 F Am Dm F
 He grabbed his pants a better stance then he jumped so high
 Bb C
 He clicked his heels
 Bb Am A7 F+ F G7 Gm7 C
 He let go a laugh oh he let go a laugh, shook back his clothes all around

Chorus
 Dm C Dm C Dm C F Am Dm C F
 Mr. Bojangles, Mr. Bojangles, Mr. Bojangles, dance

F Am Dm F Bb C
 He danced for those at minstrel shows and county fairs, throughout the South
 F Am Dm F Bb C
 He spoke with tears of fifteen years how his dog and him, traveled about
 Bb Am A7 Dm F+ F G7 Gm7 C
 His dog up and died he up and died, after twenty years he still grieves

F Am Dm F Bb C
 He said I dance now at every chance in honky tonks, for drinks and tips
 F Am Dm F Bb C
 But most o' the time I spend behind these county bars, he drinks a bit
 Bb Am A7 F+ F G7 Gm7 C
 He shook his head and as he shook his head, I heard someone ask him please

Dm C Dm C Dm C F Am Dm C F
 Mr. Bojangles, Mr. Bojangles, Mr. Bojangles, dance

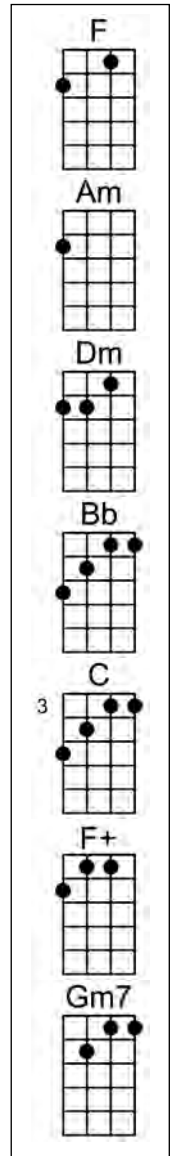

MY GRANDFATHER'S CLOCK

Intro: G D G

G D
 My grandfather's clock
 G C
 Was too large for the shelf
 G D G
 So it stood ninety years on the floor
 G D G C
 It was taller by half than the the old man himself
 G D G
 Though it weighed not a pennyweight more

G D
 It was bought on the morn
 C G
 Of the day that he was born
 G C D
 And was always his pleasure and pride
 G D G C
 It stopped, short never to go again
 G D G
 When the old man died

G C G
 Ninety years without slumbering
 G C G
 His life seconds numbering
 G D G C
 It stopped, short never to go again
 G D G
 When the old man died

G D
 My grandfather said
 G C
 that of those he could hire
 G D G
 Not a servant so faithful he found
 G D G C
 For it wasted no time and had but one desire
 G D G
 At the close of each week to be wound

Melody

A	-----0---0-	-2-3-2---	-0-0---0-----
E	---3-2-3---3---	-----0-	-----3---3-2-0-3-
C	-2-----	-----	-----
G	-----	-----	-----

HENRY CLAY WORK

Strum =dD First note =D

G D
 And it kept in its place,
 C G
 not a frown upon its face
 G C D
 And its hands never hung by its side
 G D G C
 It stopped, short never to go again
 G D G
 When the old man died

G D
 It rang and alarmed
 G C
 in the dead of the night
 G D G
 An alarm that for years had been dumb
 G D G
 And we knew that his spirit was pluming
 C
 for flight

G D G
 That his hour for departure had come

G D
 Still the clock kept the time
 C G
 with a soft and muffled chime

G C D
 As we silently stood by his side
 G D G C
 It stopped, short never to go again
 G D G
 When the old man died

G C G
 Ninety years without slumbering
 G C G
 His life seconds numbering
 G D G C

It stopped short, never to go again
 G D G
 When the old man died

NINE POUND HAMMER

TRADITIONAL

Merle Travis

Intro: F Bb F C7 F

Strum=D DU UD or fingerpick 4,1,3,2 First note=C

F Bb
This nine pound hammer, just a little too heavy

F C7 F
For my size, for my size

F Bb
I'm going on the mountain, just to see my baby

F C7 F
And I ain't coming back, no I ain't coming back

Chorus

F Bb
Well, roll on buddy don't you roll so slow

F C7 F
Well how can I roll, when the wheels won't go?

F Bb
Roll on buddy, pull you load of coal

F C7 F
Tell me how can I pull, when the wheels won't roll?

Solo

F Bb
This nine pound hammer, killed John Henry

F C7 F
But it won't get me, it won't get me,

F Bb
I'm just a poor boy, a long way from home

F C7 F
Down in Tennessee, down in Tennessee

Chorus

F Bb
It's a long way to Harlan, an' it's a long way to Hazard

F C7 F
Just to get a little brew, just to get a little brew

F Bb
And when I'm long gone, you can make my tombstone

F C7 F
Out of number nine coal, out of number nine coal

Repeat first verse

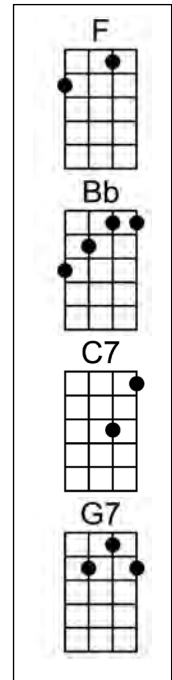

Solo

A	-----	-0-----	-----	-----	-----	-----
E	-----1-1-	-----3-1-	-----1-	-4-3-1-1-	-8-5-	-----
C	-0-2-	-----2-	-0-2-	-----2-	-----5-5-	-8-5-8-7-5-
G	-----	-----	-----	-----	-----	-5-7-

O DEATH

TRADITIONAL

Acapella or fingerpick or D DU UD

First note=D

Dm
 Death, Ooo Death,, O Death,
A7 Dm Dm

Won't you spare me over til another year?

Dm
 But what is this, that I can't see?
 Dm A7 Dm Dm
 With ice cold hands taking hold of me...

Dm
 When God is gone and the Devil takes hold,
 Dm A7 Dm
 Who will have mercy on your soul?

Dm
 Ooo Death,, O Death, Ooo Death,
A7 Dm Dm
 Won't you spare me over til another year?

Dm
 Mamma, Oh Mama, come to my bed
 Dm A7 Dm
 Place an old cold rag upon my head.

Dm
 My eyes are aching and I can't see
 Dm A7 Dm
 I feel that sheet pullin' over me

Dm
 No wealth, no ruin, no silver, no gold.
 Dm A7 Dm
 Nothing satisfies me but your soul.

Dm
 Well I am Death, none can excel,
 Dm A7 Dm
 I'll open the gates to heaven or hell.

Dm
 O Death, O Death,
 Dm A7 Dm
 My name is Death and the end is here...

Picking pattern Dm

A	-----0-----
E	-----1-----
C	---2-----0---
G	-2-----2-----

Intro

A	-----0-----
E	-----3-1---1---
C	-2-2-----2---2-2-
G	-----

Verse melody

A	---0-----0- ---0-----
E	-----3-1---1-3--- -----3-1--1-1---
C	-2-----2----- -2-----2-----
G	----- -----

Chorus melody

A	----- -----0-----
E	---1----- -----3-1-----1-----
C	-2---2-0--- -2-2-----2-2---2-2-
G	-----2- -----

Death O Death, won't you spare me over..

OKLAHOMA HILLS

WOODY AND JACK GUTHRIE

Intro: G7 C

Strum=D DU UDU

First note = C

C
Many a month has come and gone, since I wandered from my home

G7 C
In those Oklahoma hills where I was born

C F D7
Many a page of life has turned, many a lesson I have learned,

G7 C
Well, I feel like in those hills I still belong

Chorus

C F D7
'Way down yonder in the Indian Nation, ridin' my pony on the reservation

G7 C G7
In those Oklahoma hills where I was born

C F D7
Now 'way down yonder in the Indian Nation, a cowboy's life is my occupation

G7 C
In those Oklahoma hills where I was born

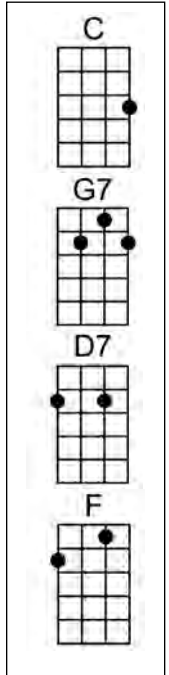

Solo

	Solo C				Alt for 2nd	
A	-----				-0-----	
E	-3-3-5-3-	-----	-----3-	-3-5-5-3-	-----	
C	-/4-4-4-4-	---0-2-0-3-2-0---	-----2-	-----	--3b-p0-----	
G	-----5-	-2-----2-	-0-0-4-----	-----	-----/5-5-	

Chorus

C F D7
Well as I turn life a page, back to the land of the great Osage

G7 C
In those Oklahoma hills where I was born

C F D7
Where the black oil rolls and flows, and the snow white cotton grows

G7 C
Well, I feel like in those hills I still belong

C F D7
But as I sat here today, many miles I am away

G7 C
From the place I rode my pony through the draw

C F D7
Where the oak and blackjack trees, kiss the playful prairie breeze

G7 C
In those Oklahoma hills where I was born

Chorus

Outro C F C G7 C

	Intro	G7	C
A	-----		
E	-3-5-7-5-3-1-0-	-----	
C	-4-5-7-5-4-2-0-	-----	
G	-----		

OLD HOME PLACE

DEAN WEBB AND MITCHELL JAYNE

Intro: C G C

Strum= D DU UDU

First note=C

C E7 F C
It's been ten long years since I left my home
G
In the hollow where I was born.
C E7 F C
Where the cool fall nights make the wood smoke rise,
G C
And a fox hunter blows his horn.

C E7 F C
I fell in love with a girl from the town
G
I thought that she would be true.
C E7 F C
I ran away to Charlottesville
G C
and worked in a sawmill or two.

Chorus

G C
What have they done to the old home place,
D G
why did they tear it down?
C E7 F C
And why did I leave the plow in the field,
G C
and look for a job in the town.

C E7 F C
Well, the girl ran off with somebody else
G
the taverns took all my pay.
C E7 F C
And here I stand where the old home stood
G C
before they took it away.

C E7 F C
Now the geese fly south and the cold wind moans
G
as I stand here and hang my head.
C E7 F C
I've lost my love, I've lost my home
G C
and now I wish that I was dead.

Chorus

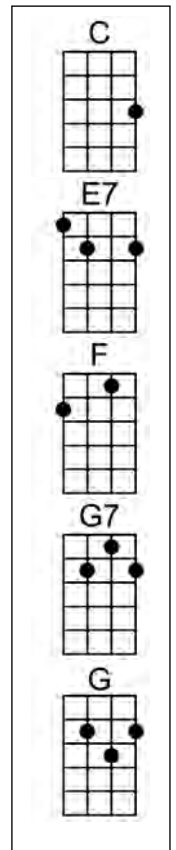

ON AND ON

BILL MONROE

Intro: G C G or below

Strum=D DU UD

First note=B

G C G
Traveling down this long lonesome highway
D7
I'm so lonesome I could cry
G C G
Memories of how we once loved each other
D7 G
And now you are saying goodbye

Intro	
A	-----2-
E	-3---0-2-3-
C	---2-----2-
G	-----

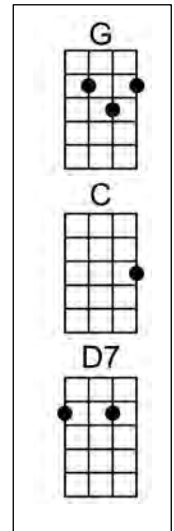

Chorus
G C G
On and on I'll follow my darling
D7
And I wonder where she can be
G C G
On and on I'll follow my darling
D7 G
And I wonder if she ever thinks of me
C G
I've cried I've cried for you little darling
D7
It breaks my heart to hear your name
G C G
My friends they also love you my darling
D7 G
And they think that I am to blame

Chorus
G C G
I have to follow you my darling
D7
I can't sleep when the sun goes down
G C G
By your side is my destination
D7 G
The road is clear and that's where I'm bound

Chorus

ON THE ROAD AGAIN

WILLIE NELSON

C

Strum=D DU UD or pick

First note=G

On the road again

E7

Just can't wait to get on the road again

Dm

The life I love is making music with my friends

F

G7

C

And I can't wait to get on the road again

C

On the road again

E7

Goin' places that I've never been

Dm

Seein' things that I may never see again

F

G7

C

C7

And I can't wait to get on the road again

F

On the road again

C

Like a band of gypsies we go down the highway

F

We're the best of friends

C

G7

Insisting that the world keep turning our way and our way

Harp Solo C harp hole 3 or uke

Chorus

C

On the road again

E7

Just can't wait to get on the road again

Dm

The life I love is making music with my friends

F

G7

C

And I can't wait to get on the road again

F

On the road again

C

Like a band of gypsies we go down the highway

F

We're the best of friends

C

G7

Insisting that the world keep turning our way and our way

Chorus - then repeat last line x2

Picking pattern	
A	-----3-----
E	-----0-----0-
C	---0-----0---
G	---0-----0-----

Solo	
A	----7-7-7- -7-6-7-8-7-5- -7-7-7- -7---7-8-7-----7-
E	----- ----- ----- --10-----10-8--
C	7-7-7-7-7- ----- -8-8-8- -----
G	----- ----- -----

A	----- -7-8-8-8-10- -7-7-7-----
E	---10-10---10- ----- -----10-8-
C	-----9----- ----- -7---7-----
G	----- ----- -----

ONE MORE DOLLAR

GILLIAN WELCH

Intro Em D C D G Gsus4 G (original in F) Strum D D UU D First note=B or fingerpick 4, 3, 2, 4, 1, 2

G D G
A long time ago I left my home
C D G
For a job in the fruit trees
G D G
But I miss those hills with windy pines
C D G
Their song seemed to suit me

G D G
So I sent my wages to my home
C D G
Said we'd soon be together
G D G
For the next good crop would pay my way
C D G
And I'd come home forever

Em D C D G
One more dime to show for my day
Em D C D G
One more dollar and I'm on my way
Em D C D G
When I reach those hills boys, I'll never roam
Em D C D G
'Cause one more dollar and I'm going home

G D G
No work said the boss at the bunkhouse door
C D G
There's a freeze on the branches
G D G
So when the dice came out at the bar down to
C D G
I rolled and I took my chances

Em D C D G
One more dime to show for my day
Em D C D G
One more dollar and I'm on my way
Em D C D G
When I reach those hills boys, I'll never roam
Em D C D G
'Cause one more dollar and I'm going home

Break G D G C D G G D G C D G

G D G
A long time ago I left my home
C D G
Just a boy passing twenty
G D G
Could you spare a coin and a Christian prayer
C D G
For my luck has turned against me

Em D C D G
One more dime to show for my day
Em D C D G
One more dollar and I'm on my way
Em D C D G
When I reach those hills boys, I'll never roam
Em D C D G
'Cause one more dollar and I'm going home

Em D C D G C G
One more dollar, boys, I'm going home

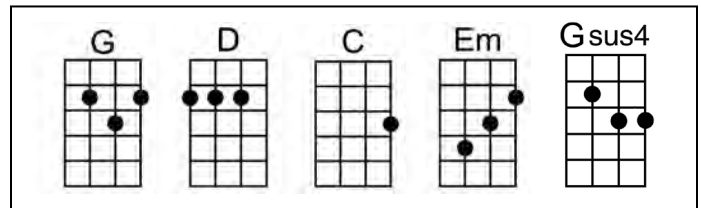

PAN AMERICAN

HANK WILLIAMS

DeFord Bailey

Intro: D x8 fast pace
or train sound on harp

Strum=dD dD dD dD First note= A

D G
I have heard your stories about your fast trains
A D
Now I'll tell you about one all the southern folks have seen
G
She's the beauty of the southlands listen to that whistle scream
A D
It's that Pan American on her way to New Orleans.

D G
She leaves Cincinnati headin' down that Dixie line
A D
When she passes that Nashville tower you can hear that whistle whine
G
Stick your head right out the window and feel that southern breeze
A D
You're on that Pan American on her way to New Orleans.

D G
If you're ever in the south lands and want to see the scenes
A D
Just get yourself a ticket on that Pan American Queen
G
Louisville and Montgomery in the state of Alabama
A D
You pass right through then all when your New Orleans bound.

D G
She leaves Cincinnati headin' down that Dixie line
A D (whistle)
When she passes that Nashville tower you can hear that whistle whine
G
Stick your head right out the window and feel that southern breeze
A D G D (V)
You're on that Pan American on her way to New Orleans.

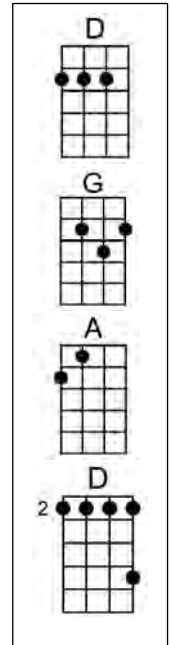

Whistle	
A	-10b-10b-
E	-12b-12b-
C	-----
G	-----

Solo				
A	-----5-8/9-9-	-9----7-9-10-	-----5-9-7-	-----5-8/9-
E	-5-5-7-----	---10-----	-5-5-----	-5-5-----
C	-----	-----	-----	-----
G	-----	-----	-----	-----

PARADISE

Intro: C G C

Strum=D DU UD

C F C
When I was a child my family would travel
G7 C
Down to Western Kentucky where my parents were born
F C
And there's a backwards old town that's often remembered
G7 C
So many times that my memories are worn

Chorus

C F C
And daddy won't you take me back to Muhlenberg County
C G7 C
Down by the Green River where Paradise lay
C F C
Well I'm sorry my son but you're too late in asking
C G7 C
Mister Peabody's coal train has hauled it away

Well sometimes we'd travel right down the Green River
To the abandoned old prison down by Adrie Hill
Where the air smelled like snakes and we'd shoot with our pistols
But empty pop bottles was all we would kill

Chorus

Then the coal company came with the world's largest shovel
And they tortured the timber and stripped all the land
Well, they dug for their coal till the land was forsaken
Then they wrote it all down as the progress of man

Chorus

When I die let my ashes float down the Green River
Let my soul roll on up to the Rochester dam
I'll be halfway to Heaven with Paradise waiting
Just five miles away from wherever I am

Chorus

JOHN PRINE

First note=G

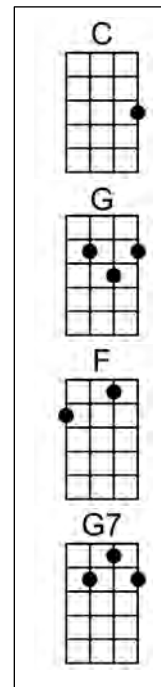

THE RACE IS ON

JOHN ROLLINS

Intro: G C C

Strum D DU UD

First note=D

I feel tears welling up from down deep inside, like my hearts got a big break
And a stab of loneliness sharp and painful that I may never shake.
You might think that I'm taking it hard since you broke me off with a call,
You might wager that Ill hide in sorrow and I might lay right down and bawl.

Chorus

Now the race is on and here comes pride up the back stretch,
Heartaches a goin' to the inside, my tears are holding back, tryin' not to fall.
My hearts out of the running, true love scratched for another's sake,
The race is on and it looks like heartaches, and the winner loses all.

Solo: Chorus and verse progressions

One day I ventured in love never once suspecting what the final result would be.
Now I live in fear of waking up each morning, and finding that you're gone from me.
There's an aching pain in my heart for the name of the one that I hated to face,
Someone else came out to win her, and I came out in second place.

Chorus

Now the race is on and here comes pride up the back stretch,
Heartaches a goin' to the inside, my tears are holding back, tryin' not to fall.
My hearts out of the running, true love scratched for another's sake,
The race is on and it looks like heartaches, and the winner loses all.

End or Solo: Chorus and Verse progressions

Chorus

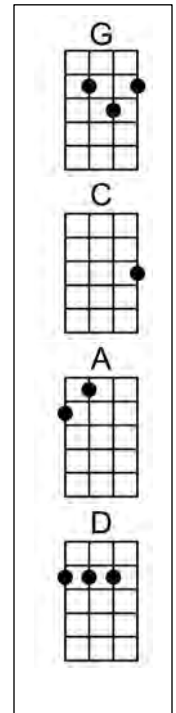

RAIN AND SNOW

MRS. TOM RICE

Intro: below or D E till ready Strum=D DU UD

First note= D

Chorus

D **E**
Well I married me a wife, she's been trouble all my life

D **E**
Run me out in the cold rain and snow

E **D** **E**
Rain and snow-oh-oh-oh-oh-oh-oh-oh-oh-oh-oh,

D **E**
Run me out in the cold rain and snow

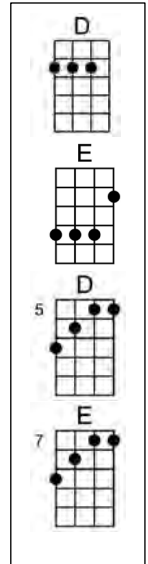

D **E**
Well she's coming down the stairs, combin' back her yellow hair

D **E**
And I ain't goin be treated this a-way

Intro

A	-2-4-5-4-0-----0-
E	-----4-2-0-2-
C	-----2-
G	-----2-

Solo

D **E**
Well she went up to her room where she sang her faithful tune

D **E**
Well I'm goin where those chilly winds don't blow

D **E**
Well I married me a wife, she's been trouble all my life

D **E**
Run me out in the cold rain and snow

E **D** **E**
Rain and snow-oh-oh-oh-oh-oh-oh-oh-oh-oh-oh,

D **E**
Run me out in the cold rain and snow

RANK STRANGERS

ALFRED E. BRUMLEY

Intro: C G7 C

3/4 time

Strum=D DU UD

First note = C

C G7 C
I wandered again to my home in the mountains
C D7 G7
Where in youths' early dawn I was happy and free
C G7 C
I looked for my friends but I never could find them
C G7 C
I found they were all rank strangers to me

C
Everybody I met (everybody I met)
F C
Seemed to be a rank stranger (seemed to be a rank stranger)
C
No mother or dad (no mother or dad)
D7 G7 D7 G7
Not a friend could I see (not a friend could I see)

C
They knew not my name (they knew not my name)
G7 C
And I knew not their faces (and I knew not their faces)
C
I found they were all (I found they were all)
G7 C F C
Rank strangers to me (rank strangers to me)

C G7 C
They've all moved away said the voice of a stranger
D7 G7
To a beautiful home by the bright crystal sea
C G7 C
Some beautiful day I'll meet them in heaven
G7 C
Where no one will be a stranger to me

[Repeat verses 2 & 3]

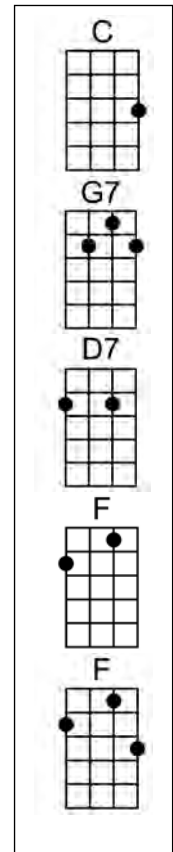

RED ROCKIN' CHAIR

TRADITIONAL

Intro: A D A D A F#m D A E7 A

Strum=dD dD dD dD

First note =C#

A D A D A F#m D
 Well I ain't got no use, well I ain't got no use for a red rockin' chair
 A F#m D A E7 A
 Ain't got no sugar baby now, ain't got no sugar baby now

Solo:over verse chords

A D A D A F#m D
 I laid her in the shade, laid her in the shade, gave her every cent I made
 A F#m D A E7 A
 What else could a poor boy do? What else could a poor boy do?

A D A D A
 Well, who'll call you honey? And who'll sing this song?
 A F#m D A
 And who'll rock the cradle when you're gone?
 A E7 A
 Who'll rock the cradle when I'm gone?

A D A D A F#m D
 Well I'll rock that cradle, I'll rock that cradle, And I'll sing this song,
 A F#m D A E7 A
 I'll rock that cradle when your gone, said I'll rock that cradle when your gone

A D A D A F#m D
 It's all I can do, it's all I can do, it's all I can say
 A F#m D A E7 A
 Go tell your mamma next payday, go tell your mamma next payday

Solo:over verse chords

Melody

A	-----9-9-----	-----9-----	-----9-9-----	-----9-9-----
E	-9-12-----12-9-	-----9-----	-----9-9-----	-----9-9-----
C	-----11-9-11-----	-----11-9-----	-----9-9-11-----	-----11-9-9-----
G	-----11-----	-----11-----	-----11-----	-----11-----

A D A D A F#m D
 I'm goin' to Montana, I'm goin' to Montana, for to get away from here,
 A F#m D A E7 A
 I can't get along here with you, can't get along here with you.

Repeat 3rd and 4th verses, then first verse

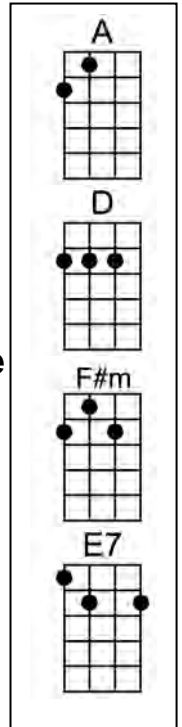

RED WING

THE STEEL WHEELS

Intro: F C G7 C

Strum = D D UU D or dD

First note= C

C F C
 In the summer sun in nineteen eighty one
 F C G7
 The day was long till I heard the song whistle like the wind
 C F C
 And I was standing there dust was flying through the air
 F C G7 C
 Like days before when we believed in things we couldn't see

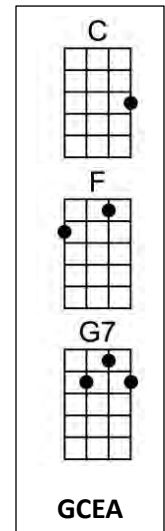

Chorus

F C
 Oh my red wing take me softly
 G7 C
 To my home now to my family
 F C
 Oh my red wing hold me closely
 G7 C
 Take me under the brightest sun

C F C
 When the day is done and another night has come
 F C G7
 I'll rest my weary bones and pray the bird I love hasn't flown away
 C F C
 And I recall again that to my kindest friends
 F C G7 C
 The ground below will be set free and with my love I'll be

Chorus

C F C
 Money she has none she was never one
 F C G7
 By metal wings or death machines or anything between
 C F C
 And when my time has come and all my days are done
 F C G7 C
 If heaven waits we'll breach the gates on her wings we'll be one

Chorus

F C
 Oh my red wing take me softly
 G7 C
 To my home now to my family
 F C
 Oh my red wing hold me closely
 G7 C
 Take me under the setting sun

Chorus melody GCEA

A	-3-1-0- - - - - - 0- - - - - - - - 0- - - - - - - - 0- - - - -
E	- - - - - 1- -3- - - 3-0- -3- - - 3- - - - -3- - - 3-0-
C	- - - - - - - - - - - - - - - - - - - 2- - - - - - - -
G	- - - - - - - - - - - - - - - - - - - - - - - - - - - -
A	-3-1-0- - - - - - 0- - - - - - - - 0- - - - - - - - - - - -
E	- - - - - 1- -3- - - 3-0- -3- - - 3- - - - -1-0- - - - -
C	- - - - - - - - - - - - - - - - - - - 2- - - - - 2-0- - -
G	- - - - - - - - - - - - - - - - - - - - - - - - - - - -

ROLL IN MY SWEET BABY'S ARMS

TRADITIONAL

Intro: G G7 C G D7 G strum or fingerpick Strum=dD dD dD dD First note=G

Chorus:

G D7
 Roll in my sweet baby's arms roll in my sweet baby's arms,
 G G7 C
 Gonna lay round the shack till the mail train comes back,
 G D7 G
 Then I'll roll in my sweet baby's arms.

G D7
 Ain't gonna work on the railroad, ain't gonna work on the farm
 G G7 C
 Gonna lay round the shack till the mail train comes back
 G D7 G
 Then I'll roll in my sweet baby's arms

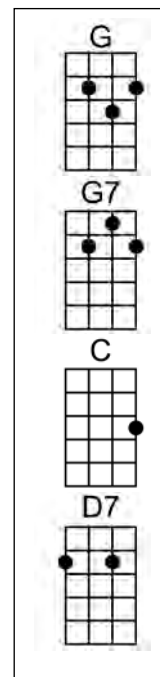

Chorus

G
 I know your parents don't like me;
 D7
 They drove me away from your door
 G G7 C
 If I had my life to live over
 G D7 G
 I'd never go there any more.

Solo

Chorus

Melody				
A	-----2-0-----	-----2-0---0-	-----2-2-3-3---	-----2-0-----
E	-3-3-3-----3-3-	-3-3-3-----3---	-3-3-3-----	-----3-3-
C	-----	-----	-----	-2-2-2-----
G	-----	-----	-----	-----

RUBY

GILLIAN WELCH

Intro C G F C

Strum D DU UD

First note=E

C Em F Fm
 Ruby, let down your golden hair, when I'm standing at the bottom of your stairs
 C Em F Fm
 Ruby, I can see your TV on, but the people there they flicker and they're gone
 F C F G
 So let down your golden hair for me tonight, let down your golden hair for me to climb

Chorus

C F C G
 Just like an old-time telegraph man, I came here with a simple job to do
 C F Fm
 Cause that news coming down the wire says that your head's on fire
 C G F C
 And I'm trying to get a message through to you

C Em F Fm
 Ruby, you ain't lonely yet, with your crystal and your Russian cigarette
 C Em F Fm
 Ruby, haven't you heard before, what good's finest tower when it hasn't got a door?
 F C F G
 So let down your golden hair for me to climb, Let down your golden hair for me tonight

Chorus

C F C G
 Just like an old-time telegraph man, I came here with a simple job to do
 C F Fm
 Cause that news coming down the wire says that your head's on fire
 C G F C
 And I'm trying to get a message through to you

Instrumental over verse chords

Play bass notes then chords

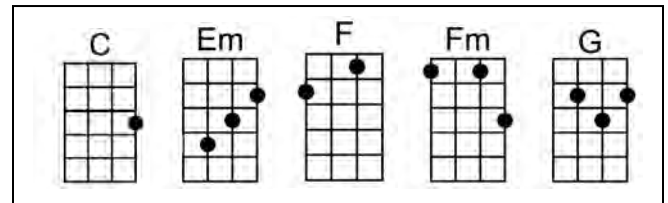

Chorus

Outro
 C Em F Fm

Chorus

Verse melody				
A	----- ----- ----- ----- ...			
E	----- ---3---5---3- ----- -----			
C	-/4\2-0- 4---4---4-- 4-4-2-0- -0-2-0-3-2-0-0-2-p0-			
G	----- ----- ----- -----			

SATIN SHEETS

JOHN VOLINKATY

Intro: C G7 C then walkup

Strum=D DUD

First note=G

C
Satin Sheets to lie on
F
Satin pillows to cry on
C G7
Still I'm not happy don't you see
C F
Big long Cadillacs tailor makes upon my back
C G7 C
Still I want you to set me free

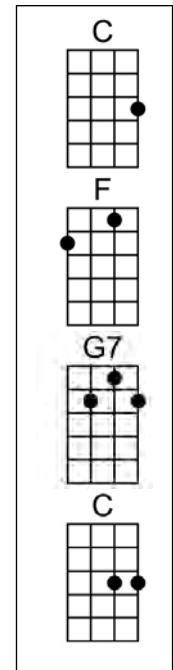
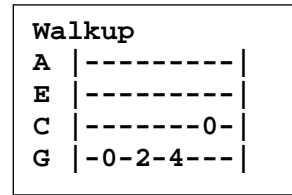

C
I've found another man
F
Who can give more than you can
C G7
Though you've given me everything money can buy
C
But your money can't hold me tight
F
Like he does on a long long night
C G7 C
You know you didn't keep me satisfied

Solo - start on G

C
Satin Sheets to lie on
F
Satin pillows to cry on
C G7
Still I'm not happy don't you see
C F
Big long Cadillacs tailor makes upon my back
C G7 C F C
Still I want you to set me free

SHADY GROVE

TRADITIONAL

Intro: F C Dm

Strum= dD dD dD dD or fingerpick

First note=D

Chorus

Dm C Dm
 Shady Grove my little love, Shady Grove I say
 F C Dm
 Shady Grove my little love, I'm bound to go away

Dm C Dm
 Cheeks as red as a blooming rose, eyes are the prettiest brown
 F C Dm
 She's the darling of my heart, sweetest girl in town

Chorus

Dm C Dm
 I wish I had a big fine horse and corn to feed him on
 F C Dm
 And Shady Grove to stay at home and feed him while I'm gone

Chorus

Dm C Dm
 Went to see my Shady Grove, she was standing in the door
 F C Dm
 Her shoes and stockin's in her hand and her little bare feet on the floor

Solo

Dm C Dm
 When I was a little boy I wanted a Barlow knife
 F C Dm
 And now I want little Shady Grove to say she'll be my wife

Chorus

Dm C Dm
 A kiss from pretty little Shady Grove is sweet as brandy wine
 F C Dm
 And there ain't no girl in this old world that's prettier than mine Play melody x 2

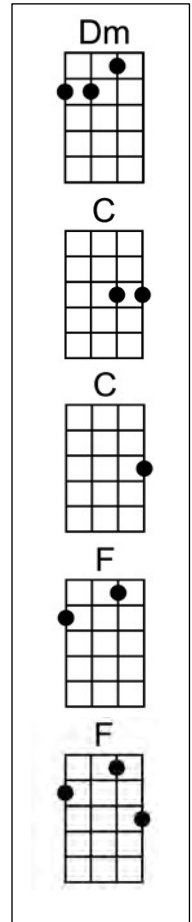

	Melody	Dm	C	Dm	F	C	Dm
A	-----	-----0-	-----3-3-0-----	-----			
E	-----0-----	-----0-3---	-----3-0---	-----0-----			
C	-----0-1-2-2-2-2-0-	-----2-2-----	-----0-	-----0-	-----2-2-----	-----0-2-	-----2-
G	-----	-----	-----	-----	-----	-----	-----

Solo	Dm	C	Dm	F	C	Dm
A	-----	-----0-	-----3-3-0-0-----	-----		
E	-----0-----	-----0-0-3---	-----3-3-0-3-0---	-----0-----		
C	-----0-1-2-2-2-2-0-	-----2-2-----	-----0-	-----0-	-----2-2-----	-----0-2-
G	-----	-----	-----	-----93-----	-----	-----

SHE THINKS I STILL CARE

DICKEY LEE AND STEVE DUFFY

C F C
 Just because I ask a friend about her
C G7 C
 Just because I spoke her name somewhere
C C7 F
 Just because I rang her number by mistake today
C G7 C
 She thinks I still care

C F C
 Just because I haunt the same old places
C G7 C
 Where the memory of her lingers everywhere
C C7 F
 Just because I'm not the happy guy I used to be
C G7 C
 She thinks I still care

F C
 But if she's happy thinking I still miss her
G7
 Then let that silly notion bring her cheer
F C
 How could she ever be so foolish
D7 G7
 Oh where would she get such an idea

Solo
C F C
 Just because I ask a friend about her
C G7 C
 Just because I spoke her name somewhere
C C7 F
 Just because I saw her then went all to pieces
C G7 C
 She thinks I still care
C G7 C F C
 She thinks I still care

Strum=D DU UD

First note=G

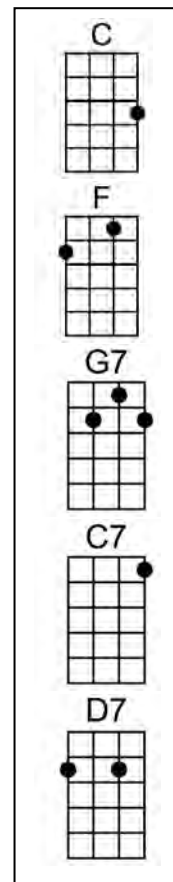

Solo - melody

A	-----	-7-7-5-7-8-5-7-5---	-----7-7-5-7-8-7-5-----	-7-----5---
E	-----5-5-8-8-5---	-----8-	-----8-8-5-	-----8-7---8-
C	7-7---7-----7-	-----	-----7-	-----7-7-----
G	-----5-----	-----	-----	-----

SITTING ON TOP OF THE WORLD

WALTER VINSON
LONNIE CHATMON

Intro: below

Strum=dD dD dD dD

First note=A

Was in the summer one early fall
 Just tryin' to find my little all and all
 Now she's gone an' I don't worry
 Lord, I'm sittin' on top of the world

One summer day, she went away
 She went and left me, now she gone to stay
 My baby's gone but I can't worry
 I'm sittin' on top of the world

Now don't come runnin', holdin' out your hand
 I'll get me a woman, quick as you can get a man
 Now she's gone an' I don't worry
 Lord, I'm sittin' on top of the world.

Worked all the summer, worked all fall
 Had to take Christmas, in my overalls
 But now she gone and I don't gonna worry
 I'm sittin' on top of the world

I'm going down to the station, down in the yard,
 Gonna catch me a freight train, work done got hard
 But now she gone and I don't worry
 I'm sittin' on top of the world

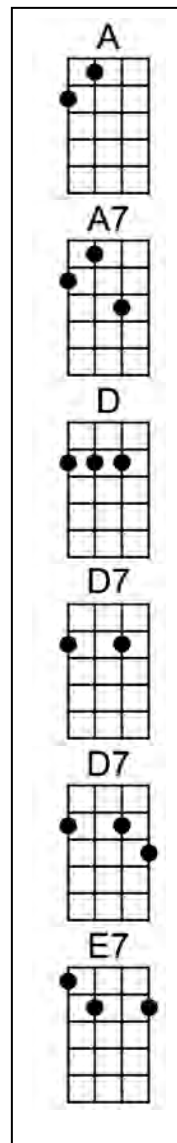

INTRO

WALKDOWN

E7

A	---	0---	0-----	0-----	0-----		-2-2--2-2--2-2--2-2	
E	-----	3---	3-2---	2-1---	1-0-		-0-0--0-0--0-0--0-0	
C	-----	-----	-----	-----	-----		-2-2--2-2--2-2--2-2	
G	-2-----	-----	-----	-----	-----		-1-1--1-1--1-1--1-1	

SIX DAYS ON THE ROAD

EARL GREEN & CARL MONTGOMERY

G D7 G
Well I pulled outa Pittsburgh a rollin' down that Eastern Seaboard

I got my diesel wound up and she's a runnin' like a never before

C D7 G C
There's a speed zone ahead alright I don't see a cop in sight

G D7 G
Six days on the road and I'm a gonna make it home tonight

D7 G D7 G
I got ten forward gears and a Georgia overdrive

I'm takin' little white pills and my eyes are open wide

C D7 G C
I just passed a Jimmy and a White I been a passin' everything in sight

G D7 G
Six days on the road and I'm a gonna make it home tonight

G D7 G
Well it seems like a month since I kissed my baby goodbye

I could have a lotta women but I'm not like a some other guys

C D7 G C
I could find one to hold me tight but I could never make believe it's alright

G D7 G
Six days on the road and I'm a gonna make it home tonight

D7 G D7 G
Well the I C C is a checkin' on down the line

Well I'm a little overweight and my log book's way behind

C D7 G C
But nothin' bothers me tonight I can dodge all the scales alright

G D7 G
Six days on the road and I'm a gonna make it home tonight

D7 G D7 G
Well my rig's a little old but that don't mean she's slow

There's a flame from her stack and that smoke's a blowin' black as coal

C D7 G C
My hometown's a comin' in sight if you think I'm a happy you're right

G D7 G
Six days on the road and I'm a gonna make it home tonight

Six days on the road and I'm a gonna make it home tonight

First note = D

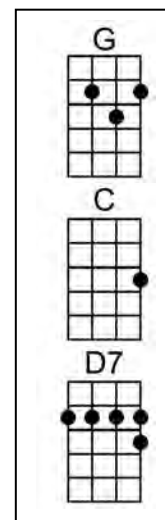

SUNNY SIDE OF THE MOUNTAIN

HARRY C. MCAULIFFE
& BOBBY GREGORY

Intro: D or below

Strum= dD or D DU UD

First note=A

D G
Now don't forget me little darling while I'm growing old and gray

A D
Just a little thought before I'm going far away

D G
I'll be waiting on the hillside for the day you will call

A D
On the sunny side of the mountain where the rippling waters fall

D G
Tell me darling in your letters do you ever think of me

A D
Ah, tell me ... little darling tell me where you can be

G
I'll be waiting on the hillside for the day you will call

A D
On the sunny side of the mountain where the rippling waters fall

D G
Don't forget about the days we courted many years ago

A D
Don't forget all those promises you made me and so

G
Cause I'll be waiting on the hillside for the day you will call

A D
On the sunny side of the mountain where the rippling waters fall

D G
It's been so long since I've seen you but your love still lingers on

A D
Don't forget me little darling though our love affair is gone

G
Cause I'll be waiting on the hillside for the day you will call

A D
On the sunny side of the mountain where the rippling waters fall

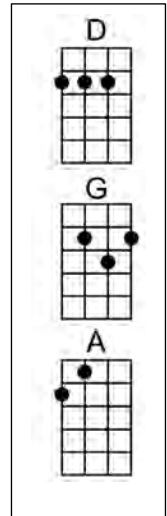

Intro	
A	-----0-
E	-2-3-4-
C	-2-2-2-2-
G	-----

Melody		D		repeat 1 st 3 then	
A	-0-0-2-2-	-2-0-	-----	-----	-----
E	-2-	-----2-0h2-2-0-	-0-0-0-0 2-0-	-----	-----
C	-2-	-----2-	-----2-	-1-1-	-1-1-1-
G	-2-	-----0-	-----	-2-4-2-2-	-2-2-2-4-

SWEET DREAMS

PATSY CLINE

Intro G C D7 G or below

Strum=D DU UDU

First note=G

G A7 D7

Sweet dreams of you

G A7 D7

Every night I go through

G C G C

Why can't I forget you and start my life anew

G C D7 G C G D7

Instead of having sweet dreams about you

G A7 D7

You don't love me, it's plain

G A7 D7

I should know I'll never wear your ring

G C G Am

I should hate you the whole night through

G C D7 G D7

Instead of having sweet dreams about you

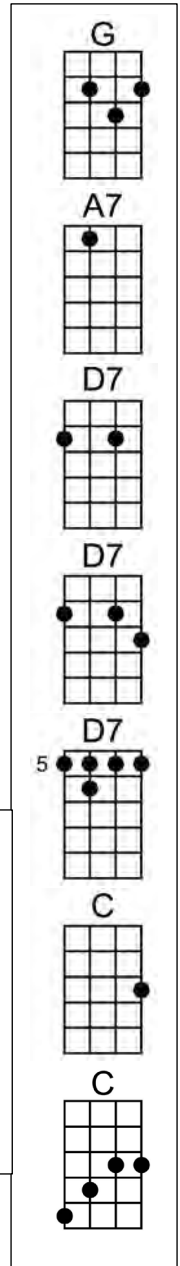

Solo
over verse chords

Solo

A	-----	---0---	-----
E	-3-0-	-----	-2---3- -0-----
C	-----	2-1-2-	-----
G	-----	-----	-----

A	-----	-----	-----	-----
E	-3-3-0-	---0-----	-----3-0-	-----
C	-----	0-----	-----2-2-	-----0-
G	-----	0-----4-4-	4-----0-	4-2-0-

G A7 D7

Sweet dreams of you

G A7 D7

Things I know can't come true

G C G C

Why can't I forget the past, start loving someone new

G C D7 G C G

Instead of having sweet dreams about you

Intro

A	-10-9-8-7-	-8-7-6-5-	-6-5-4-3-	-4-3-2-1-	-2-1-0-----
E	-----	-----	-----	-----	-----3-3-
C	-----	-----	-----	-----	-----2-
G	-----	-----	-----	-----	-----0-

SWEET SUNNY SOUTH

TRADITIONAL

Intro: G C G D G strum or fingerpick Strum=dD dD dD dD

First note=G

G
Take me back to the place where I first saw the light

G C
To the sweet sunny south take me home

G
Where the mockingbirds sing me to rest every night

G D G
Oh, why was I tempted to roam?

I think with regret of the dear home I left
Of the warm hearts that sheltered me there
Of wife and of dear ones of whom I'm bereft
For the old place again do I sigh

Take me back to the place where the orange trees grow
To my plot in the evergreen shade
Where the flowers from the river's green margins did grow
And spread their sweet scent through the glade

Oh the path to our cottage they say has grown green
And the place is quite lonely around
I know that the smiles and the forms I have seen
Now lie in the dark mossy ground

Take me back, let me see what is left that I knew
Can it be that the old house is gone?
Dear friends of my childhood indeed must be few
And I must face death all alone

But yet I'll return to the place of my birth
Where the children have played round the door
Where they gathered wild blossoms that grow round the path
They'll echo our footsteps no more

Take me back to the place where my little ones sleep
Poor Massa lies buried close by
By the graves of my loved ones, I long for to weep
And among them to rest when I die

Repeat first verse

Melody...

A	-----	-----	-----	-----8-----	-----	-----
E	-----	-----	-7-8-10-10-7-----7-8-	-7-8-10-10---10-	-8-7-----	-7-----
C	-----7-7-10-7-	-----7-7-----	-----7-9-----	-----	-----7-7-----	---7-----6-8-7-
G	-7-9-----	-7-9-----10-7-	-----	-----	-----10-7-	-----9-7-----

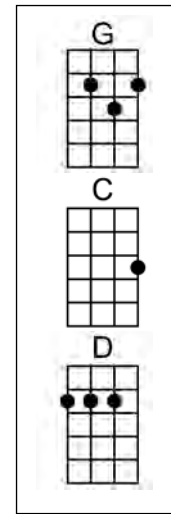

SWING LOW, SWEET CHARIOT

TRADITIONAL

Intro C G7 C

Strum pattern: D DU UD

First Note= E

Chorus

C F C G7
Swing low, sweet chariot, comin' for to carry me home
C C7 F C G7 C
Swing low, sweet chariot, comin' for to carry me home

C F C
I looked over Jordan, and what did I see,
C G7
Comin' for to carry me home.
C F C
A band of angels comin' after me,
C G7 C
Comin' for to carry me home.

Chorus

C F C
If you get there before I do,
C G7
Comin' for to carry me home.
C F C
Just tell my friends that I'm a'comin' too,
C G7 C
Comin' for to carry me home

Chorus

C F C
I'm sometimes up and sometimes down,
G7
Comin' for to carry me home.
C F C
But still my soul feels heavenly bound
C G7 C
Comin' for to carry me home.

Chorus

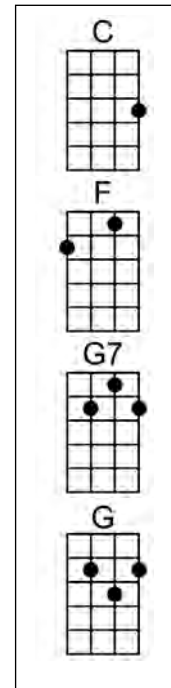

SWINGING DOORS

MERLE HAGGARD

Intro: below

Strum= D DU UDU or dD dD dD dD

First note=B

G C
 This old smoke filled bar is something I'm not used to
 G D7
 But I gave up my home to see you satisfied
 G C
 And I just called to let you know where I'll be living
 G D7 G
 It's not much but I feel welcome here inside

G C
 And I've got swinging doors a jukebox and a bar stool
 G D7
 And my new home has a flashing neon sign
 G C
 Stop by and see me any time you want to
 G D7 G
 Cause I'm always here at home till closing time

Solo

G C
 I've got everything I need to drive me crazy
 G D7
 I've got everything it takes to lose my mind
 G C
 And in here the atmosphere's just right for heartaches
 G D7 G
 Thanks to you I'm always here till closing time

G C
 And I've got swinging doors a jukebox and a bar stool
 G D7
 And my new home has a flashing neon sign
 G C
 Stop by and see me any time you want to
 G D7 G
 Cause I'm always here at home till closing time
 G D7 G C G
 Cause I'm always here at home till closing time

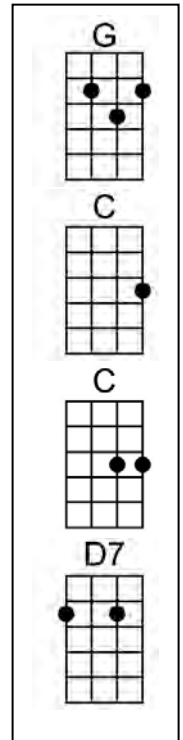

Intro	
A	--7-5--3-2-----0-----
E	-----3-----
C	-7--6-2----2-0-----
G	-----

Solo	
A	-5-5-----7-5----- ----- -1---0-----2---
E	----8-7-----7b8-7- -5---5---0-3- ---3---3-0-3-3---
C	-----7----- ---7---2----- -----
G	----- ----- -----

TAKE THIS HAMMER

Intro F C7 F Strum= dD dD dD dD

or fingerpick 4,1,3,2
Bb harp 2nd position

C F
Workin' on a railroad, dollar a day
C F
Workin' on a railroad, dollar a day
Dm C F
Workin' on a railroad, dollar a day
Dm C F
Get my money, get my pay

Chorus

C F
Take this hammer, take it to the captain
C F
Take this hammer, carry it to my captain
Dm C F
Take this hammer, carry it to my captain
Dm C F
Tell him I'm gone, tell him I'm gone

Solo over chorus

C F
If he asks you, was I running
C F
If he asks you, was I running
Dm C F
If he asks you, was I running
Dm C F
Tell him I was flying, tell him I was flying

Chorus

C F
If he asks you, was I laughing
C F
If he asks you, was I laughing
Dm C F
If he asks you, was I laughing
Dm C F
Tell him I was crying, tell him I was crying

Chorus

C F
Workin' on a railroad, dollar a day
C F
Workin' on a railroad, dollar a day
Dm C F
Workin' on a railroad, dollar a day
Dm C F
Get my money, get my pay
Dm C F Dm C F Bb F
Get my money, get my pay, get my money, get my pay

TRADITIONAL

Harry Manx version
First note=C

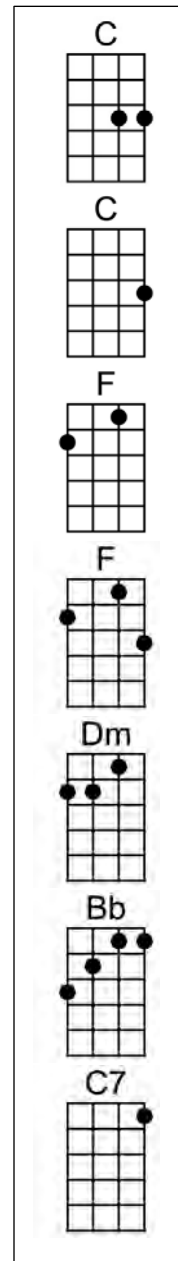

THAT'S ALRIGHT MAMA

ARTHUR CRUDUP

Intro below

Strum dD dD dD dD

First note=E

A
Well, that's alright, mama
A
That's alright for you
A A7
That's alright mama, just anyway you do
D
Well, that's alright, that's alright.
E7 A
That's alright now mama, anyway you do

Intro/ Turnaround/Ending	
E	----0---0--0----- ^{E7} -0h2-2-
B	-/3-----2--1----- -----0-
G	-/4---4-3--2---h1-- -----2-
D	----- -----1-

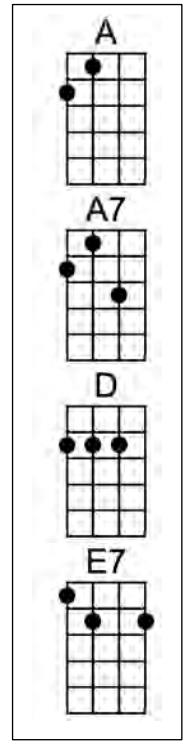

A
Well, Mama she done told me,
A
Papa done told me too
A A7
'Son, that gal your foolin' with, she ain't no good for you'
D
But, that's alright, that's alright.
E7 A
That's alright now mama, anyway you do

Solo

Solo			
A	-7-5-4-5-7- -7-5-4-7- -7-5-4-5-7- -7-9-10-9-7-		
E	-9-7-5-7-9- -9-7-5-9- -9-7-5-7-9- -----10-8b9-		
C	----- ----- ----- -----		
G	----- ----- ----- -----		
A	----- ----- -7-7-10-9-7-7- -12-7-7-7-		
E	-----8b9- -----8b9- -----10- -----10-8-		
C	-7-7- -7-7- ----- -----9-		
G	----- ----- ----- -----		

A
I'm leaving town, baby
A
I'm leaving town for sure
A A7
Well, then you wont be bothered with me hanging 'round your door
D
Well, that's alright, that's alright.
E7 A
That's alright now mama, anyway you do

THIS LAND IS YOUR LAND

WOODY GUTHRIE

Intro: C G7 C

Strum=dD dD dD dD

First note=C

C F C
This land is your land this land is my land
G7 C
From California to the New York Island
F C
From the Redwood forests to the Gulf Stream waters
G7 C
This land was made for you and me
F C
As I was walking that ribbon of highway
G7 C
I saw above me an endless skyway
F C
I saw below me a golden valley
G7 C
This land was made for you and me

F C
I roamed and rambled and followed my footsteps
G7 C
Through the sparkling sands of her diamond deserts
F C
And all around me a voice was sounding
G7 C
This land was made for you and me

C F C
As I went rambling that dusty highway
G7 C
I saw a sign that said "Private Property"
F C
But on the other side, it didn't say nothin'
G7 C
That side was made for you and me

C F C
This land is your land this land is my land
G7 C
From California to the New York Island
F C
From the Redwood Forests to the Gulf Stream waters
G7 C
This land was made for you and me

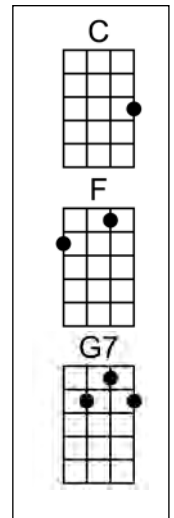

THIS TRAIN

TRADITIONAL

Sister Rosetta Tharpe
First note=G

Intro G D7 G Strum= dD dD dD dD

G D7
This train is bound for glory, this train. This train is bound for glory, this train.

G C7
This train is bound for glory, don't carry nothin'' but the righteous and the holy.

G D7 G
This train is bound for glory, this train.

G D7
This train don't carry no gamblers, this train. This train don't carry no gamblers, this train.

G C7
This train don't carry no gamblers, no crap shooters nor midnight rambles.

G D G
This train don't carry no gamblers, this train

G D7
This train don't carry no jokers, this train. This train don't carry no jokers, this train.

G C7
This train don't carry no jokers, high-toned women or cigar smokers.

G D7 G
This train don't carry no jokers, this train.

G D7
This train don't carry no liars, this train. This train don't carry no liars, this train.

G C7
This train don't carry no liars, no slow-walkers, or midnight flyers.

G D7 G
This train don't carry no liars, this train.

G D7
This train's the last train, this train. This train's the last train, this train.

G C7
This train's the last train, if you don't board it, you ain't comin' back again.

G D7 G
This train's the last train, this train.

G D7
This train is bound for glory, this train. This train is bound for glory, this train.

G C7
This train is bound for glory, don't carry nothin'' but the righteous and the holy.

G D7 G
This train is bound for glory, this train.

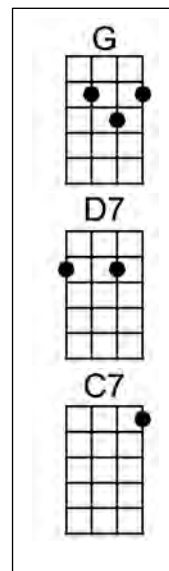

TOGETHER AGAIN

BUCK OWENS

Intro: below

Strum D DU UDU

First note=A

Chorus

D7 G

Together again

My tears have stopped falling

D7

The long lonely nights

G D7

Are now at an end

The key to my heart

C

You hold in your hand

D7

But nothing else matters

G D7

Now we're together again

Together again

The gray skies are gone

D7

You're back in my arms

G D7

Right where you belong

The love that we knew

C

Is living again

D7

And nothing else matters

G D7

We're together again

Chorus

The key to my heart

C

You hold in your hand

D7

But nothing else matters

G

Now we're together again tag last 2 lines end with

G C G

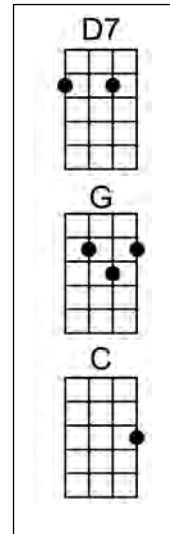

	Intro		G D7
A	-----	-----	-2-0-
E	-3-3-2-0-0-	-----	-3-2-
C	-----2-	-----0-	-2-0-
G	-----	-2-2-4-4-2-0-	-0-2-

WAITING FOR A TRAIN

JIMMIE RODGERS

First note=E

Intro – below or yodel C F G7 C

C G7 C C7 F Fm C
 All around the water tank waiting for a train
 F C Am D7 G7
 A thousand miles away from home sleeping in the rain
 C G7 C C7 F Fm C
 I walked up to a brakeman just to give him a line of talk
 F C D7 G7
 He said if you've got money I'll see that you don't walk
 C G7 C C7 F Fm C
 Well I haven't got a nickel not a penny can I show
 F C A7 D7 G7 C
 He said get off you railroad bum and he slammed the boxcar door

Solo

G7 C G7 C C7 F Fm C
 Well he put me off in Texas a place I dearly love
 F C D7 G7
 The wide open spaces all around me the moon and stars above
 C G7 C C7 F Fm C
 Nobody seems to want me nor to lend me a helping hand
 F C D7 G7
 I'm on my way from Frisco heading back to Dixie Land
 C G7 C C7 F Fm C
 My pocketbook is empty my heart is full of pain
 F C A7 D7 G7 C
 I'm a thousand miles away from home just waiting for a train

Yodel
 C F G7 C

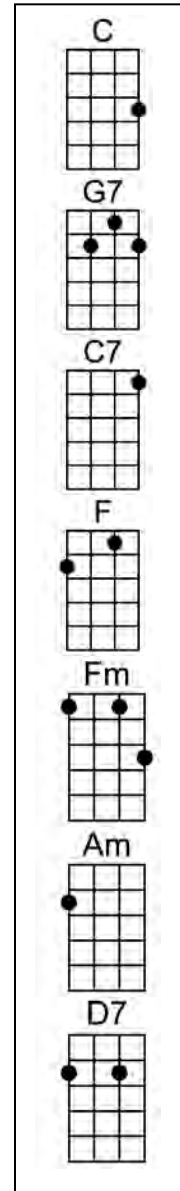

Intro- also at end of chorus/song or yodel /=slide into note

A-----7-	-----5-----3-	-----	-3-
E-----	-----	-3-5-3-----	-3-
C--4-5---7--	--4-/5--3-/4--	-----3-4---	-4-
G-----	-----	-----5-	-5-

Solo

A-----	-----	-----0-----	-----
E-----3-	-1-1-----	-----3-0---	-----0---3-
C-2-3-4---2-4-0-2-4-	-----0-2-4-	-----0-0-----0-	-2-2---2---
G-----	-----	-0-2-----	-----

WALKIN' DOWN THE LINE

BOB DYLAN

First note = F#

CHORUS

Well, I'm walkin' down the line, I'm walkin' down the line
An' I'm walkin' down the line
My feet'll be a-flyin', to tell you 'bout my troubled mind
I got a heavy-headed gal, I got a heavy-headed gal
I got a heavy-headed gal
She ain't a-feelin' well, when she's better only time will tell

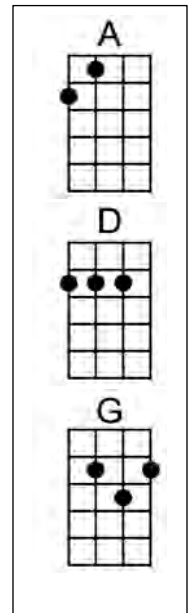

CHORUS

My money comes and goes, my money comes and goes
My money comes and goes
And rolls and flows and rolls and flows
Through the holes in the pockets in my clothes

CHORUS

I see the morning light, I see the morning light
Well, it's not because I'm an early riser, I didn't go to sleep last night

CHORUS

I got my walkin' shoes, I got my walkin' shoes, I got my walkin' shoes
An' I ain't a-gonna lose, I believe I got the walkin' blues

CHORUS

WE'RE ALL IN THIS TOGETHER

OLD CROW MEDICINE SHOW

Intro: C E7 F C

Strum= D DU UD

First note=C

C E7 F C
Well my friend, I see your face so clearly
Am G
Little bit tired, little worn through the years
C E7 F C
You sound nervous, you seem alone
Am G
I hardly recognize your voice on the telephone

C E7 F C
In between I remember
Am G
Just before we wound up, broken-down
C E7 F C
We drive out to the edge of the highway
Am G F F
Follow that lonesome dead-end road sign south

Chorus:

C E7 F C
We're all in this thing together
Am G
Walkin' the line between faith and fear
C E7 F C
This life don't last forever
Am G F
When you cry I taste the salt in your tears

C E7 F C
Well my friend, let's put this thing together
Am G
And walk the path with worn out feet have trod
C E7 F C
If you wanted we can go on forever
Am G F F
Give up your jaded ways, spell your name to God

Chorus

C E7 F C
All we are is a picture in a mirror
Am G
Fancy shoes to grace our feet
C E7 F C
All there is is a slow road to freedom
Am G F F
Heaven above and the devil beneath

Chorus

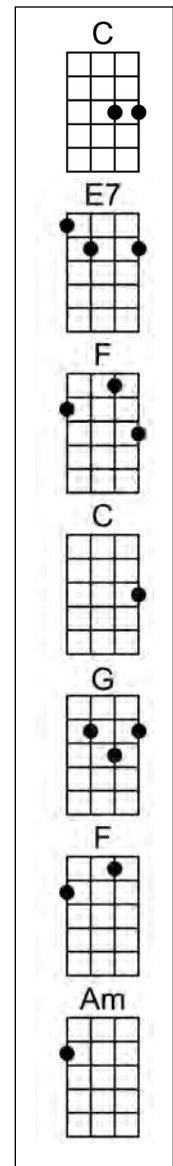

WHEN THE SAINTS GO MARCHING IN

JAMES MCPARKLAND

Intro: C G7 C

Strum=D DU UDU

First note=C

Chorus

C
Oh when the saints go marching in

G7
When the saints go marching in

C7 F
I want to be in that number

C G7 C
When the saints go marching in

C
And when the sun refuse to shine

G7
And when the sun refuse to shine

C F
I still want to be in that number

C G7 C
When the sun refuse to shine

C
O when the stars have disappeared,

G7
O when the stars have disappeared,

C7 F
Lord, I want to be in that number

C G7 C
When the stars have disappeared,

C
Oh when the saints go marching in

G7
When the saints go marching in

C F
I'm gonna sing as loud as thunder

C G7 C
Oh when the saints go marching in

Chorus

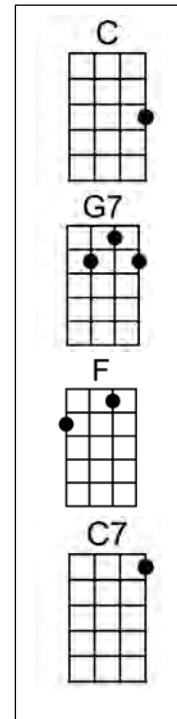

WHISKEY IN THE JAR

TRADITIONAL IRISH

Intro: C G7 C

Strum= D DU UD

First note=E

C Am
As I was a goin' over Gilgarra mountain,
F C Am
I met Colonel Pepper and his money he was counting
F C Am
I drew forth my pistol and rattled my saber
F C Am
Saying, "Stand and deliver, for I am a bold deceiver."

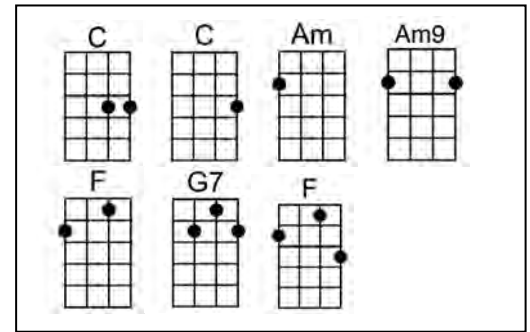

CHORUS – after each verse

G G7
Musha ringum duram da
C C7
Whack! Fol de daddy-o
F
Whack! Fol de daddy-o
C G7 C
There's whiskey in the jar

Verse					
A	-----0-----	-0-0-2-0---		-----0-0-2-3-3-2-0-	-----3-2-0---	
E		-0-3-3-----3-0-	-----0-0-	-3-----	-3-3-----0-	
C		-----	-----	-----	-----	
G		-----	-----	-----	-----	
Chorus						
A		-----	-----	-0-0---0-2-3-	-----	
E		-1-0-----0-1-	-0-0---0-1-3-	-----3-----	-1-0-0-----	
C		-----2-2-0-2-----	-----2-----	-----	-----2-2-0-	
G		-----	-----	-----	-----	

The shining yellow coins did sure look bright and jolly
I took the money home and I gave it to my Molly
She promised and she vowed that she never would deceive me
But the devil's in the women and they never can be easy

When I awoke between the hours of six and seven
Guards were standing 'round me in numbers odd and even
I flew to my pistol, but alas, I was mistaken
I fired off my pistols and a prisoner was taken

They put me in jail without a judge or jury
For robbing Colonel Pepper in the morning so early
They didn't take my fist so I knocked down the sentry
And I bid a long farewell to that cold penitentiary

Some take delight in fishing and bowling
Others take delight in the carriage a rollin'
I take delight in the juice of the barley
Courting pretty women in the mornin' so early

Harp tab C harp

↑	↑	↑	↑	↓	↑	↑	↑	↓	↓	↓	↓	↑	
6	7	7	7	7	7	6	7	7	7	8	7	6	
↑	↓	↓	↓	↓	↑	↓	↓	↑	↑	↑	φ	↓	↑
7	7	7	7	8	8	8	7	7	7	8	8	7	6
↑	↑	↑	↓	↑	↑	↑	↓	↓	↓	↓	↑		
7	7	7	7	7	6	7	7	7	7	8	7	6	
↑	↓	↓	↓	↓	↑	↓	↓	↑	↑	↑	↓	↓	↑
6	7	7	7	8	8	8	7	7	7	8	8	7	6
↓	↑	↓	↓	↑	↓	↑	↓	↑	↑	↑	↓	↑	
6	6	5	5	5	6	6	6	6	6	6	6	6	7
↓	↓	↑	↓	↓	↑	↑	↑	↓	↓	↑			
7	7	7	7	8	8	7	6	6	5	5			

WHITE FREIGHT LINER

TOWNES VAN ZANT

Intro: C G C

Strum= D DU UD

First note=C

C F C
I'm goin' out on the highway, listen to them big trucks whine
F C
I'm goin' out on the highway, listen to them big trucks whine
G F C
Ah, white freight liner, won't you steal away my mind

C F C
Well, New Mexico ain't bad, Lord and people here they treat you kind
F C
Ah, New Mexico ain't bad, Lord and people here they treat you kind
G F C
Ah, white freight liner, won't you steal away my mind

C F C
Well, it's bad news from Houston, half my friends are dying
F C
Well, it's bad news from Houston, half my friends are dying
G F C
White freight liner won't you steal away my mind

C F C
Lordy Lord, I'm gonna ramble, 'till I get back to where I came
F C
Oh, Lord, I'm gonna ramble, 'till I get back to where I came
G F C
That white freight liner's gonna haul away my brain

C F C
I'm goin' out on the highway, listen to them big trucks whine
F C
I'm goin' out on the highway, listen to them big trucks whine
G F C
Ah, white freight liner, won't you steal away my mind

Solo harp or uke (starts on C)

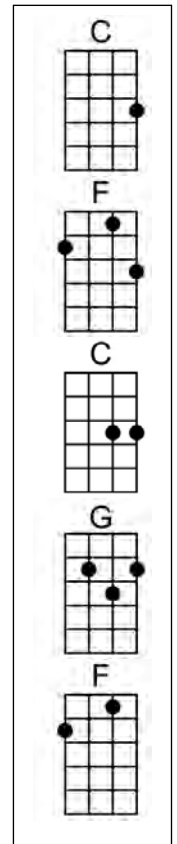

WILD HORSES

JAGGER/RICHARDS

Intro: C Dm7 C Dm7 C

Strum=D DU UDU

First note = G

Em C Em C
 Childhood living, is easy to do
 Dm F G C G
 The things that you wanted, I bought them for you
 Em C Em C
 Graceless lady, you know who I am
 Dm F G C G
 You know I can't let you, slide from my hand
 Dm F G C Bb F
 Wild horses, couldn't drag me away
 Dm F G C Bb F C
 Wild wild horses, couldn't drag me away

Em C Em C
 I watched you suffer, a dull aching pain
 Dm F G C G
 Now you've decided, to show me the same
 Em C Em C
 No sweeping exits, or offstage lights
 Dm F G C G
 Can make me feel bitter, or treat you unkind
 Dm F G C Bb F
 Wild horses, couldn't drag me away
 Dm F G C Bb F C
 Wild wild horses, couldn't drag me away

Solo over : Em C Em C Dm F G C G

Em C Em C
 Faith has been broken, tears must be cried
 Dm F G C G
 Let's do some living, after we die
 Dm F G C Bb F
 Wild horses, couldn't drag me away
 Dm F G C Bb F
 Wild wild horses, we'll ride them some day

Dm F G C Bb F
 Wild horses, couldn't drag me away
 Dm F G C Bb F G C
 Wild wild horses, we'll ride them some day

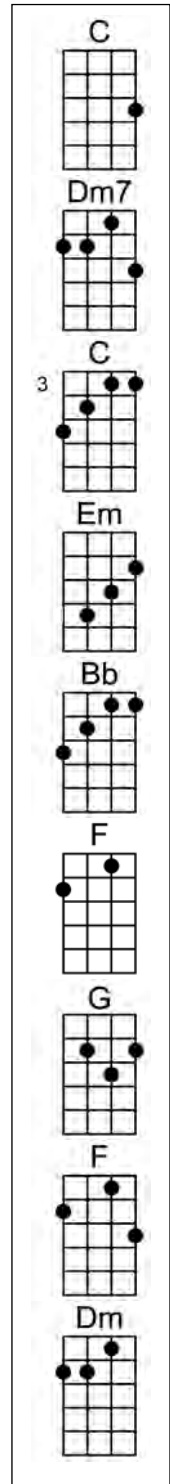

WILD SIDE OF LIFE

HANK WILLIAMS

Intro: below or C

Strum=D DU UDU or dD

First note= E

C F
 You wouldn't read my letter if I wrote you
 G7 C
 You asked me not to call you on the phone
 F
 But there's something I'm wanting to tell you
 G7 C
 So I wrote it in the words of this song.

Chorus

C F
 I didn't know God made honky tonk angels
 G7 C
 I should have known you'd never make a wife
 F
 You gave up the only one that ever loved you
 G7 C
 And went back to the wild side of life.

C F
 The glamor of the gay night life has lured you
 G7 C
 To the places where the wine and liquor flows
 F
 Where you wait to be anybody's baby
 G7 C
 And forget the only love you'll ever know.

Chorus

C F
 It hurt me to know that you don't love me,
 G7 C
 Though I know our love's forever gone,
 F
 And it killed my soul and pride dear inside me,
 G7 C
 When I saw you in that stranger's arms so long.

Chorus

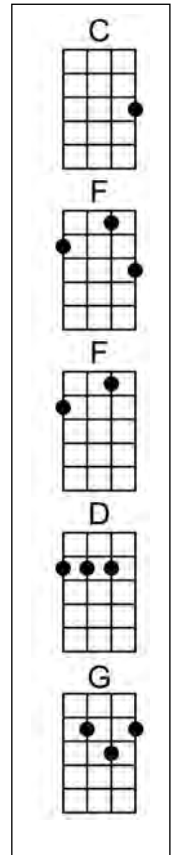

Intro	
A	--5-7-8- ---7-8-10-7-----
E	----- -10-----10-8-
C	-5-7-9-- -----
G	----- -----

Outro	
A	-0-0--- -----
E	-----3- ---0-1-3-0-----
C	----- -2-----2-0-
G	----- -----

WILDWOOD FLOWER

A. P. CARTER

Intro: C C G C

Strum=D D DUDU

First note=E

C G7 C
Oh I'll twine with my mingles and waving black hair

G7 C
With the roses so red and the lilies so fair

F C
And the myrtle so bright with the emerald hue

G7 C
The pale amanita and eyes look like blue

G7 C
Oh I'll dance I will sing and my laugh shall be gay

G7 C
I will charm every heart in her crown I will sway

F C
When I woke from my dreaming my idol was clay

G7 C
All portion of love had all flown away

G7 C
Oh she taught me to love her and promised to love

G7 C
And to cherish me over all others above

F C
How my heart is now wondering no misery can tell

G7 C
She's left me no warning no words of farewell

G7 C
Oh she taught me to love her and called me her flower

G7 C
That was blooming to cheer her through life's dreary hour

F C
Oh I long to see her and regret the dark hour

G7 C
She's gone and neglected this pale wildwood flower

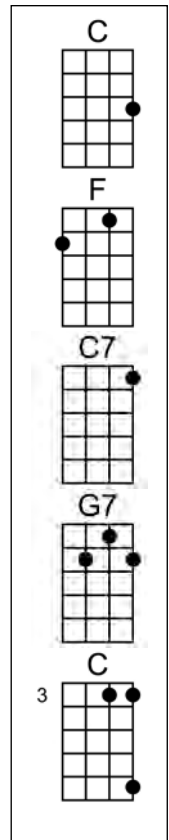

Melody / Solo

A	-----0-3-	-----	-----0-3-	-----
E	-0-1-3-----	-0-1-0--0----	-0-1-3-----	-0-1-0--0----
C	-----	-----2--2-0-	-----	-----2--2-0-
G	-----	-----	-----	-----

A	-----7-7-----	-----	-----	-----
E	---8-----10-8-	-8-7---8----	-----3-	-----
C	-7-----	-----9---9-7-	-3h4-4-4----	-4-2-4-2-----
G	-----	-----	-----	-----4-5-

WILL THE CIRCLE BE UNBROKEN

ADA R. HABERSHON

Adapted

First note=D

Strum= dD dD dD dD

G
There are loved ones in the glory,
C G
Whose dear forms you often miss;
Em
When you close your earthly story,
G D G
Will you join them in their bliss?

CHORUS

G G7
Will the circle be unbroken
C G
By and by, Lord, by and by?
Em
There's a better home awaiting
G D G
In the sky, Lord, in the sky

In the joyous days of childhood,
Oft you felt their wondrous love,
Gathered all around you
Now they dwell in heaven above.

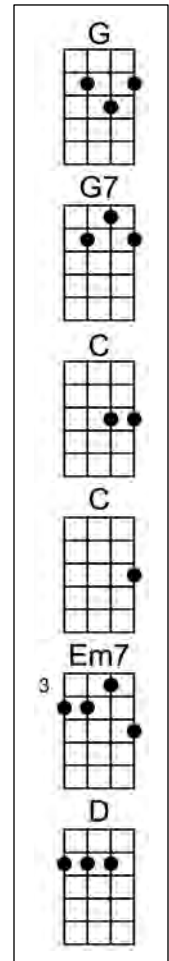

Solo

Can you see the happy gath'rings
'Round the fireside long ago,
And you think of tearful partings, Intro
When they left you here below.

Chorus

A	---0-2----- -2---0-----2-0- -----2-----
E	-3-----3--- ---3--2---2--- -----3-----3---
C	-----2----- -2-----2----- --2-----2-----
G	-4-----0- -----2----- -0---0-----0-

One by one their seats were emptied,
One by one they went away;
And the circle has been broken
Will it be complete one day?

Chorus Chorus melody

A	----- -2-0---2- -2-0--- -0----- ----- -2-5-5-2- ---0-2-2-0-2-0---
E	---0-3-3- -----3--- -----3- ---3-0--- ---0-3-3- ----- -3-----3-
C	-2----- ----- ----- -----2- -2----- ----- -----
G	----- ----- ----- ----- ----- ----- -----

WITH BODY AND SOUL

VIRGINIA STOUFFER

Bill Monroe

Intro: G F G or below

Strum= D DU UDU

First note=D

G F G
See the train comin' around the bend

G F D7
Carryin' the one that I love

G C G
Her beautiful body is still here on earth

D7 G
But her soul has been called above

Chorus

G F G C
Body and soul body and soul

G D7 G
That's how she loved me with body and soul

G F G
Her beautiful hair was the purest of gold

F D7
Her eyes were blue as the sea

G C G
Her lips were the color of summer's red rose

D7 G
And she promised she would always love me

Chorus

G F G
Tomorrow as the sun sinks low

F G
The shadows will cover her face

C G
Her last sun goes down as she's laid beneath the ground

D7 G
And my teardrops are falling like rain

G F G C
Body and soul body and soul

G D7 G D7 G
That's how she loved me with body and soul

Intro	G
A	-----2--
E	---0-2-3--
C	-2-----2--
G	-----0--

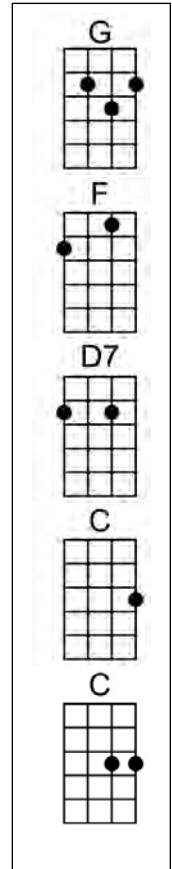

THE WRECK OF THE OLD 97

CARSON ROBISON

Intro: G D7 G

Strum=dD dD dD dD

First note = F#

G C
They give him his orders at Monroe Virginia

G D7
Saying Steve you're way behind time

G C
This is not 38 but this is Old 97

G D7 G
Put her into Spencer on time

C
Then he looked 'round says to his black greasy fireman

G D7
Just shovel on a little more coal

G C
And when we cross that White Oak Mountain

G D7 G
You can watch Old 97 roll

C
It's a mighty rough road from Lynchburg to Danville,

G D7
In a line on a three-mile grade.

G C
It was on that grade that he lost his average,

G D7 C
And you'll see what a jump he made.

C
He was going down grade making 90 miles an hour

G D7
When his whistle broke into a scream

G C
He was found in the wreck with his hand on the throttle

G D7 G
And was scalded to death by the steam

C
Now ladies you must take warning

G D7
From this time on and learn

G C
Never speak harsh words to your true loving husband

G D7 G
He may leave you and never return

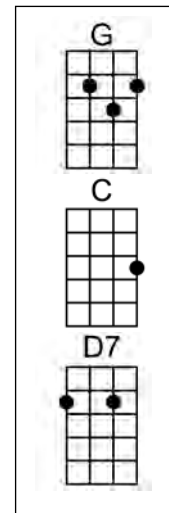

YOU AIN'T GOING NOWHERE

BOB DYLAN

Intro: G Am C G or below

Strum= D DU UD

First note=B

G Am
 Clouds so swift, the rain won't lift
 C G
 The gates won't close, the railings froze
 Am
 Get your mind off wintertime
 C G
 You ain't going nowhere

Chorus
 G Am
 Ooo-wee, ride me high
 C G
 Tomorrow's the day my gal's gonna come
 Am
 Ooh, ooh, are we gonna fly
 C G
 Down in the easy chair

G Am
 I don't care how many letters they sent
 C G
 The morning came and the morning went
 Am
 Pick up your money, pack up your tent,
 C G
 You ain't going nowhere

Chorus [then Solo]

G Am
 Buy me a flute and a gun that shoots
 C G
 Tailgates and substitutes
 Am
 Strap yourself to the tree with roots
 C G
 You ain't going nowhere

Chorus

G Am
 Gengis Khan he could not keep
 C G
 All his kings supplied with sleep
 Am
 We'll climb that hill no matter how steep
 C G
 When we get up to it

Chorus

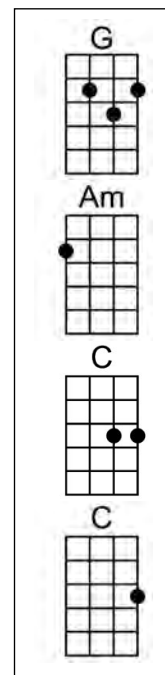

Intro- /=slide into note, b=bend, r=release bend				
A	----- ----- ----- ----- -----			
E	----- -/7-10-7- -----7- ----- -----			
C	-----7- ----- -9-7-9---9-7- ---9b10r9-7---7- -----			
G	-7-7-9--- ----- ----- -9-----9--- -3-3-3-2-0-			

YOU ARE MY SUNSHINE

Intro: C G7 C

Strum=D DU UD

C
The other night dear as I lay sleeping,
F C
I dreamed I held you in my arms
F C
But when I woke dear, I was mistaken
G7 C
And I hung my head and I cried

Chorus

C
You are my sunshine, my only sunshine.
F C
You make me happy, when skies are grey
F C
You'll never know dear, how much I love you
G7 C
Please don't take my sunshine away

C
I'll always love you and make you happy
F C
If you will only say the same
F C
But if you leave me and love another
G7 C
You'll regret it all someday

Chorus or Solo over melody

C
But if you stay dear, I'll always love you
F C
And then you'll love me one the same
F C
We'll have each other and be so happy,
G7 C
Our love will burn a brighter flame

C
You are my sunshine, my only sunshine.
F C
You make me happy, when skies are grey
F C
You'll never know dear, how much I love you
G7 C
Please don't take my sunshine away

OLIVER HOOD

Jimmie Davis & Chas Mitchell

First note=G

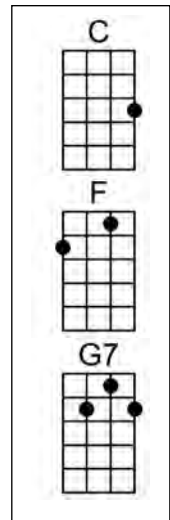

Melody				
A	-----0-----	-----0-----	-----0-----	-----0-----
E	-----0-0-0-	-----0-0-0-	-----0-1-1-	-----3-1-0-
C	-----0-2-----	-----2-0-0-	-----0-2-----	-----0-----
G	-----0-----	-----0-----	-----0-----	-----0-----
A	-----0-----	-----0-----	-----0-----	-----0-----
E	-----0-1-1-	-----3-1-0-	-----0-1-1-	-----0-1-1-
C	-----0-2-----	-----2-0-0-	-----0-2-----	-----2-2-2-
G	-----0-----	-----0-----	-----0-----	-----0-----

G7 C
Please don't take my sunshine away

YOU WIN AGAIN

HANK WILLIAMS

Intro: C G C

Strum= D DU UD

First note=G

G7 C F
The news is out, all over town
C G7
That you've been seen, out runnin' 'round.
C F
I know that I should leave but then,
C G7 C C7
I just can't go, you win again.

G7 C F
This heart of mine, could never see
D G7
What everybody knows but me
C F
Just trustin' you was my great sin,
C G7 C C7
I just can't go, Lord, you win again.

C F
You have no heart, you have no shame
C G7
You take true love, and give the blame
C F
I guess that I, should not complain
C G7 C C7
I love you still, you win again
C G7 C
What can I do, you win again.

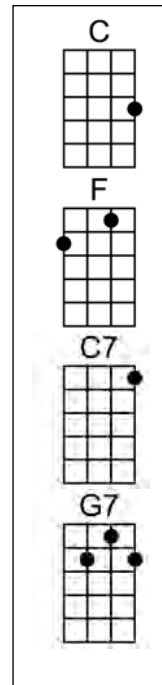

Melody / Solo

A	-----	-----	---0-3---	-----	-----	---0-3---	-----
E	-3-0----	-0-----	-1-----3-	-0-3-0--	3-0----	-0-----	-1-3-3- 0-----
C	----2-0-	---2-0---0-	-----	-----2-	---2-0-	---2---0-	-----2-0
G	-----	-----2---	-----	-----	-----2---	-----	---4-----

A	-0-0---0-	-----0---	-----	-0-----	-----	---0-3---	-----
E	----1---	-3-1---3-	-----0-3-	---3-0--	-3-3-0--	-0-----	1-----3- 0-----
C	-----	-----	-0-0----	-----2-	-----0-	---2-0---0-	-----2-0
G	-----	-----	-----	-----	-----	-----4---	---4-----